



**POLISH MANUFACTURER
OF CONSTRUCTION TOOLS
AND PAINTING ACCESSORIES**

The logo features a solid orange square to the left of the word "SOLID" in large, white, bold, sans-serif capital letters. Below "SOLID" is the word "TOOLS" in a smaller, orange, bold, sans-serif font. A registered trademark symbol (®) is located to the right of "SOLID".

SOLID[®] TOOLS

CATALOG
2026

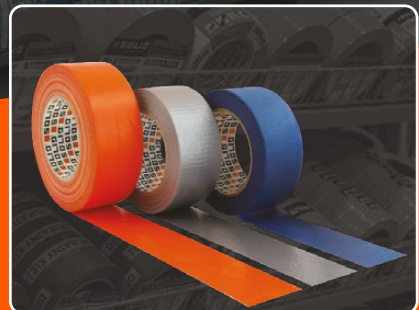

■ SOLID ■ ECONOMIC SERIES

	About the company	2
■	Leveling system	4
■	Suction cups	14
■	Knee pads	15
■	Protective gloves	16
■	Work coveralls and fleeces	24
■	Markers and pencils	26
■	Utility knives and blades	30
■	Measuring tapes	37
■	Telescopic support poles	39
■	Paint brushes	40
■	Paint roller handles	46
■	Telescopic handles	49
■	Paint trays	50
■	Paint rollers and sets	54
■	Masking tapes	63
■	Waste bags	76
■	Protective foils	79
■	Skimming spatulas	86
■	Spatulas	92
■	Plastering trowels	98
■	Masonry trowels	118
■	Tiling tools	125
■	Mixing paddles	130
■	Other products	132
■	Display stands	138

CONTENTS

O FIRMIE

ABOUT THE COMPANY

Nasza firma rozpoczęła działalność w 2001 roku. Posiadamy własne zakłady produkcyjne zlokalizowane w okolicy Gdańska, w których powstają ręczne narzędzia budowlane, systemy poziomowania płytek, artykuły malarskie i produkty foliowe. Poprzez własny dział handlowy zaopatrujemy ponad 2500 marketów i składów budowlanych na terenie Polski i Europy. Jako firma zawsze staramy się budować długoterminową współpracę, której bazą jest wzajemne zaufanie oraz odpowiedzialność.

Zapraszamy do współpracy.

Our company was founded in 2001. We have our own production plants located near Gdansk where hand construction tools, tile leveling systems, painting tools and foil products are manufactured.

Through our own sales department we supply over 2500 DIY stores and construction warehouses in Poland and Europe. As a company we always try to build a long-term cooperation with our customers, based on the trust, honest and responsibility.

We are looking forward to doing business with you.

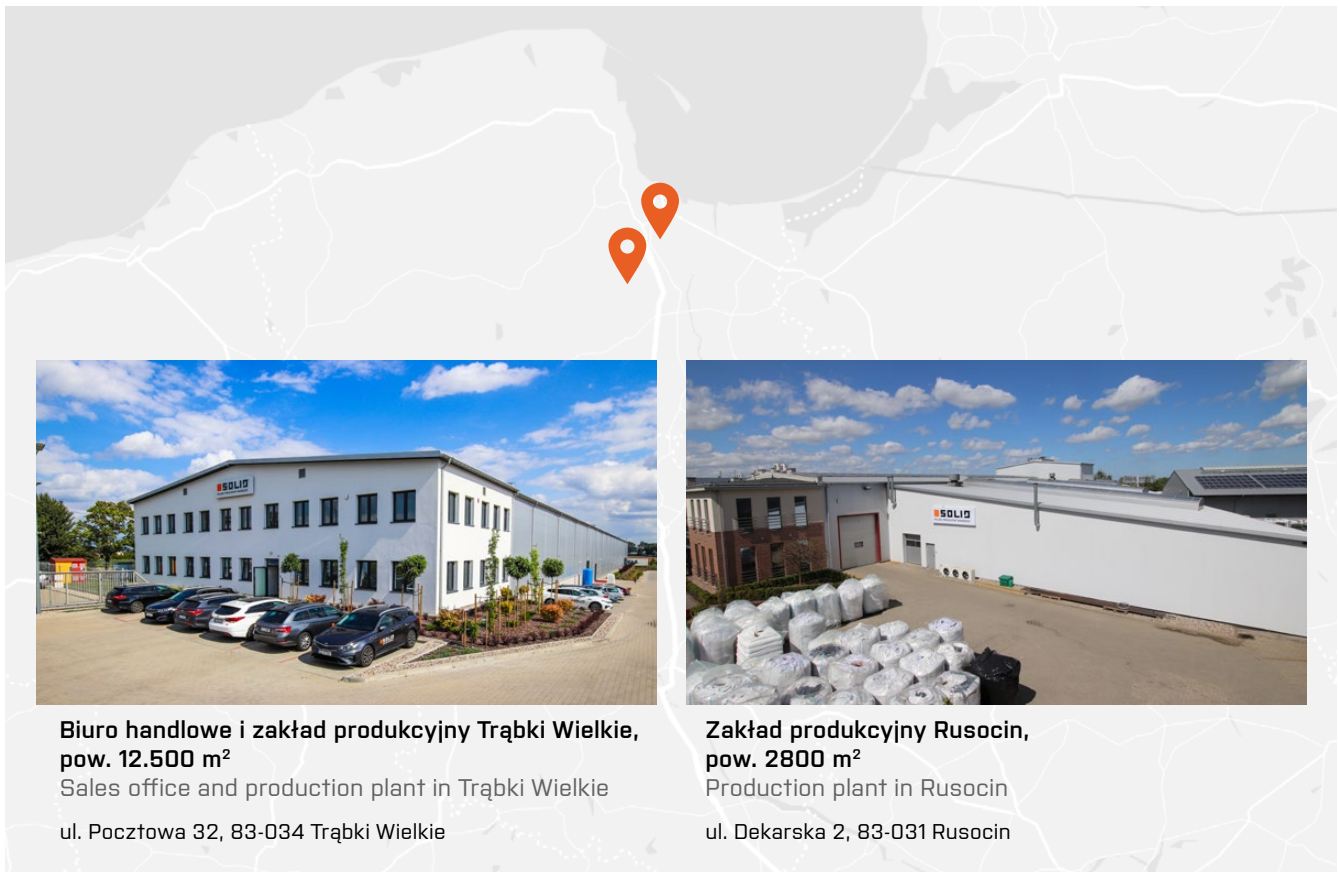

**Biuro handlowe i zakład produkcyjny Trąbki Wielkie,
pow. 12.500 m²**

Sales office and production plant in Trąbki Wielkie

ul. Pocztowa 32, 83-034 Trąbki Wielkie

**Zakład produkcyjny Rusocin,
pow. 2800 m²**

Production plant in Rusocin

ul. Dekarska 2, 83-031 Rusocin

 **SOLID**
SOLID TOOLS

Produkty pod marką SOLID przeznaczone są dla profesjonalnych wykonawców budowlanych, którzy doceniają wysoką jakość i niezawodność używanych narzędzi. Do produkcji naszych wyrobów używamy wyłącznie najwyższej jakości komponentów, takich jak stal pochodząca z renomowanych europejskich hut czy wysokogatunkowe tworzywa sztuczne. Proces produkcji jest stale monitorowany, dzięki czemu uzyskujemy produkty najwyższej jakości.

Products under the SOLID brand are designed for professional building contractors who appreciate the high quality and reliability of the tools. For the production of our products we use only the highest quality components such as steel from renowned European producers and high quality plastics. The production process is constantly monitored thanks to which we obtain products of the highest quality.











LEVELING SYSTEM

nr 1 BEST QUALITY



CHOOSE THE RIGHT SYSTEM COMPONENTS **SOLID**:









<p>Clips STANDARD for tiles from 3mm to 16mm thick</p>  <p>1 mm 1,5 mm 2 mm 3 mm</p>				<p>Clips MAXI for tiles from 25mm to 36mm thick</p>  <p>3 mm</p>	
<p>Clips MEGA for tiles from 15mm to 26mm thick</p>  <p>1 mm 1,5 mm 2 mm 3 mm</p>				<p>Locking pliers</p> 	
<p>Leveling bracket</p> 	<p>Protective wedge platform</p> 	<p>Wedge STANDARD</p> 	<p>Wedge PREMIUM</p> 		

CHOOSE THE NUMBER OF CLIPS YOU NEED:

tile size	25x40	33x33	40x40	45x45	50x50	60x60	60x30	80x80	100x50	120x60
pieces / m²	38	32	24	18	14	10	22	6	6	5

Clips Standard 100 pcs.

Designed for tiles from 3 to 16 mm thick

index	grout width	type		EAN	clips 
6358	1 mm	standard	10	 5 906554 511205	
6460	1,5 mm	standard	10	 5 903076 908216	
6461	2 mm	standard	10	 5 903076 908223	
6462	3 mm	standard	10	 5 903076 908230	

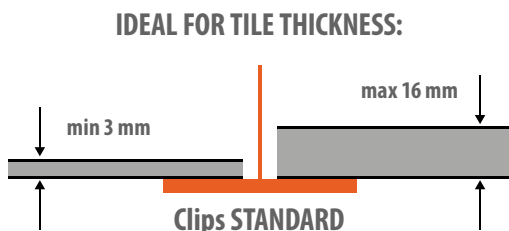

Clips Mega 100 pcs.

Designed for tiles ranging from 15 to 26 mm thick.
Ideal for tiles up to 2 cm thick

index	grout width	type		EAN	clips 
6493	1 mm	mega	10	 5 903076 905239	
6494	1,5 mm	mega	10	 5 903076 905246	
6495	2 mm	mega	8	 5 903076 905253	
6496	3 mm	mega	8	 5 903076 905260	

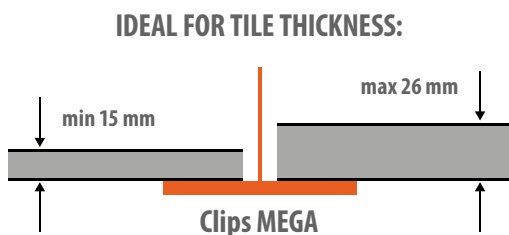

Clips Maxi 100 pcs.

Designed for tiles 25 to 36 mm thick. Ideal for tiles 3 cm thick



index	grout width	type		EAN	clips
6497	3 mm	maxi	6	5 903076 905277	

IDEAL FOR TILE THICKNESS:

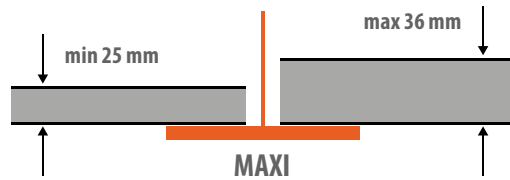





Clips Standard 400 + 40 pcs.



index	grout width	type		EAN	clips
6465	1 mm	standard	2	5 903076 900128	
6466	1,5 mm	standard	2	5 903076 900166	
6467	2 mm	standard	2	5 903076 900210	
6468	3 mm	standard	2	5 903076 902641	

Clips Standard 400 + 40 pcs.





index	grout width	type		EAN	clips
6470	1 mm	standard	4	5 903076 900784	
6471	1,5 mm	standard	4	5 903076 900791	
6472	2 mm	standard	4	5 903076 900807	
6473	3 mm	standard	4	5 903076 900814	



**+
40 pcs.
FREE!**

Clips Standard 800 pcs. + bucket 20L

Durable, reusable, graduated bucket with a capacity of 20L

index	grout width	type		EAN	clips
6451	1 mm	standard	1	5 903076 907356	
6452	1,5 mm	standard	1	5 903076 907363	
6453	2 mm	standard	1	5 903076 907370	



Wedge standard



index	quantity	packaging		EAN
6359	50 pcs.	bag	10	5 906554 511212
6459	100 pcs.	bucket	4	5 903076 900227



Wedge premium



index	quantity	packaging		EAN
6456	50 pcs.	bag	10	5 903076 900715



Locking pliers

They guarantee quick installation, precise pressure, and a perfect end result. Thanks to their solid construction and adjustable pressure mechanism, you'll achieve even joints effortlessly. Perfect for both professionals and DIY enthusiasts.



index		EAN
6464	10	5 903076 908209

■ Clips Standard 100 pcs. + wedge 50 pcs. + pliers

index	size	type	☒	EAN
6356	1 mm	standard	4	5 903076 900111



■ Clips Standard 100 pcs. + wedge 50 pcs.

index	size	type	☒	EAN
6357	1 mm	standard	4	5 906554 511199



CHOOSE THE RIGHT SYSTEM COMPONENTS **MINI**:

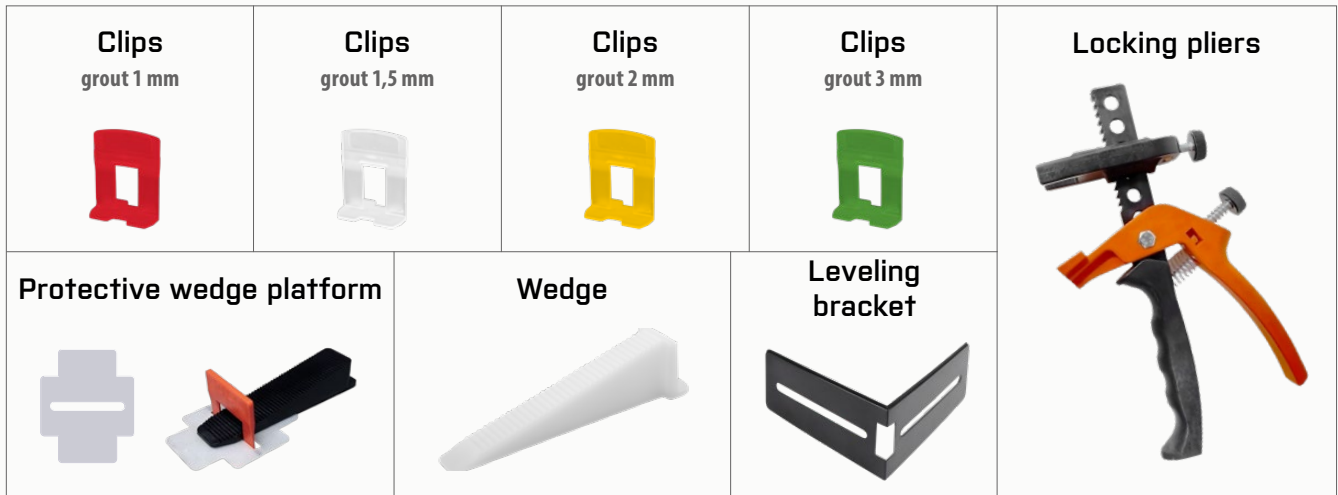

■ Clips mini 100 pcs.

For narrow or small-sized tiles. They offer the same high quality as the standard SOLID tile leveling system, but with their smaller dimensions, they provide greater comfort when working in confined spaces. Designed for tiles ranging from 4 to 12 mm thick.

index	grout width	type	☐	EAN	clips
6960	1 mm	mini	10	5 903076 913562	
6961	1,5 mm	mini	10	5 903076 913579	
6962	2 mm	mini	10	5 903076 913586	
6963	3 mm	mini	10	5 903076 913593	

■ Wedge mini

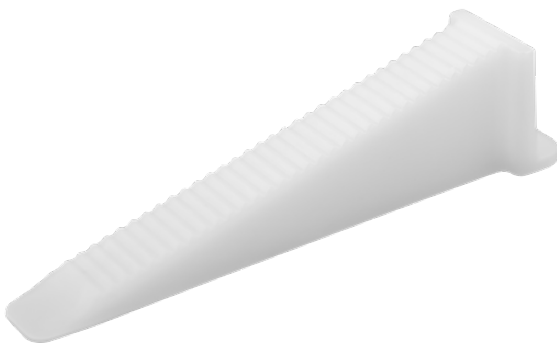

index	quantity	packaging	☐	EAN
6964	50 pcs.	bag	10	5 903076 913609

- **Protective wedge platform 50 pcs.**
 Perfect for protecting delicate tiles from scratching

index		EAN
6457	12	



- **Leveling bracket 10 pcs.**

index		EAN
6458	16	















- **Star tile spacers**
 Grout width: 1,0; 1,5; 2,0; 2,5 and 3,0 mm

index	packaging		EAN
6492	50 pcs.	160	



- **MULTI tile spacers**

index	size	packaging	color		EAN
6488	1,0 mm	50 pcs.	 	80	
6489	1,5 mm	50 pcs.	 	80	
6490	2,0 mm	50 pcs.	 	80	
6491	3,0 mm	50 pcs.	 	80	



Tile spacers

index	size	packaging		EAN
5599	1 mm	150 pcs.	50	5 906554 511922
5600	1,5 mm	150 pcs.	50	5 906554 513094
5601	2 mm	150 pcs.	50	5 906554 513100
5602	2,5 mm	150 pcs.	50	5 906554 513117
5603	3 mm	125 pcs.	50	5 906554 513124
5604	3,5 mm	100 pcs.	50	5 906554 513131
5605	4 mm	100 pcs.	50	5 906554 513148
5606	5 mm	75 pcs.	50	5 906554 513155
5607	6 mm	50 pcs.	50	5 906554 513162
5608	8 mm	30 pcs.	50	5 906554 513179
5609	10 mm	30 pcs.	50	5 906554 513186

Tile wedges

index	size	packaging		EAN
5610	mały	100 pcs.	50	5 906554 513193
5611	duży	50 pcs.	50	5 906554 513209



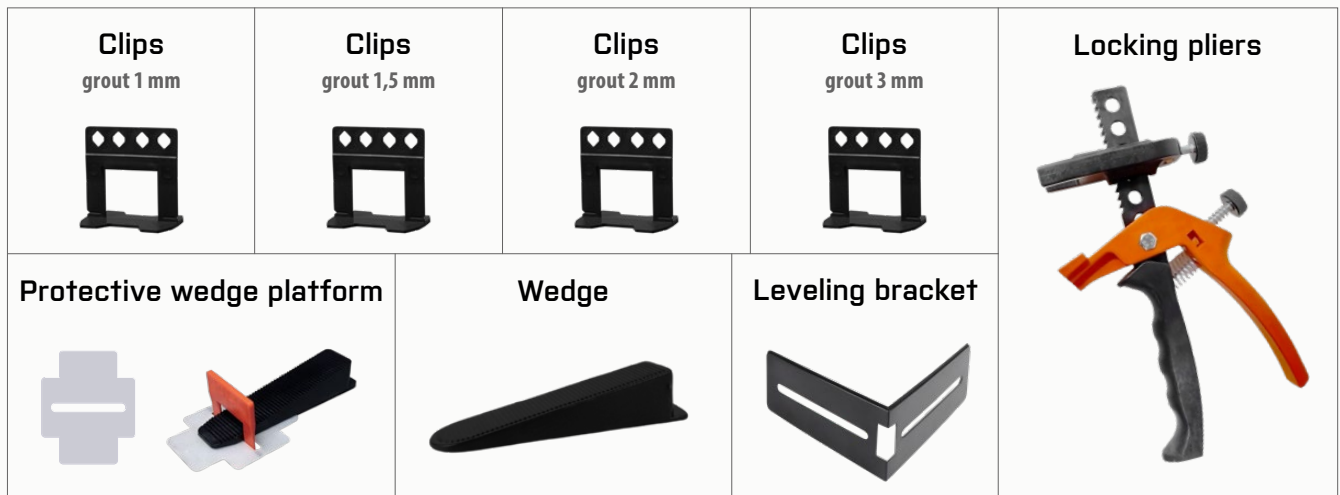

Tile spacers

index	size	packaging		EAN
5616	6 mm	50 pcs.	50	5 906554 513322
5612	8 mm	30 pcs.	50	5 906554 513216
5613	10 mm	30 pcs.	50	5 906554 513223

CHOOSE THE RIGHT SYSTEM COMPONENTS **KARO**:



■ Clips 100 pcs.

index	size		EAN
5911	1 mm	10	
5912	1,5 mm	10	
5913	2 mm	10	
5914	3 mm	10	



■ Wedge 50 pcs.

index		EAN
5910	10	





SUCTION CUPS



■ **Suction cup with pressure gauge**

Glass and tile clamp with pressure gauge, suction cup diameter 200 mm, load capacity up to 200 kg. Equipped with a pressure gauge for vacuum control. Designed for handling smooth, non-porous surfaces.

index	lifting capacity	diameter		EAN
6374	200 kg	200 mm	10	 5 903076 913043



■ **Double aluminum suction cup**



Aluminum construction, max. lifting capacity 100 kg

index	lifting capacity	diameter		EAN
6375	100 kg	2x 118 mm	24	 5 903076 913050



■ **Single suction cup**

Plastic construction, max. lifting capacity 40 kg

index	lifting capacity	diameter		EAN
6376	40 kg	118 mm	40	 5 903076 913067

WORK KNEE PADS



■ Velcro gel knee pads IDOL

Non-scratch surface, knee support, double fastening

index		EAN
82000	10	 5 903076 911209



■ Knee pads IDOL

Designed for heavy-duty work, durable, comfortable mounting

index		EAN
82001	10	 5 903076 911216



■ Foam knee pads IDOL

Practical and universal

index		EAN
82002	36	 5 903076 911223



■ Inserts knee pads IDOL

Work trousers inserts

index		EAN
82003	36	 5 903076 911230





PROTECTIVE GLOVES



Protective gloves IDOL ND60

- Durable micro-foam nitrile
- Dots for enhanced grip
- Nylon + spandex fabric – perfect fit

index	size	packaging		EAN
80119	6/XS	blister	12/120	5 903076 911247
80120	7/S	blister	12/120	5 903076 908360
80121	8/M	blister	12/120	5 903076 906601
80122	9/L	blister	12/120	5 903076 906618
80123	10/XL	blister	12/120	5 903076 906625
80124	11/XXL	blister	12/120	5 903076 906632



Protective gloves IDOL NS60







- Durable nitrile microfoam
- Precise grip
- Nylon + spandex fabric – perfect fit

index	size	packaging		EAN
80131	8/M	blister	12/120	5 903076 906649
80132	9/L	blister	12/120	5 903076 906656
80133	10/XL	blister	12/120	5 903076 906663
80134	11/XXL	blister	12/120	5 903076 906670



Protective gloves IDOL SPIDER

- Durable latex foam
- Structured for improved grip
- Nylon + spandex fabric – perfect fit





index	size	packaging		EAN
80190	7/S	blister	12/120	 5 903076 908483
80186	8/M	blister	12/120	 5 903076 907431
80187	9/L	blister	12/120	 5 903076 907448
80188	10/XL	blister	12/120	 5 903076 907455
80189	11/XXL	blister	12/120	 5 903076 907462



Protective gloves IDOL AC5

- Durable cut-resistant polyurethane coating
- C-class protective gloves
- Polyester + spandex fabric – perfect fit





index	size	packaging		EAN
81197	9/L	blister	12/120	 5 903076 910516
81198	10/XL	blister	12/120	 5 903076 910523
81199	11/XXL	blister	12/120	 5 903076 910530



Protective gloves IDOL LX80

- Grip-enhancing structure
- High weight
- Polyester fabric

index	size	packaging		EAN
80202	9/L	blister	12/120	 5 903076 910646
80203	10/XL	blister	12/120	 5 903076 910653





Protective gloves IDOL CG65

- Crinkle latex coating
- Heavy-weight
- Polyester fabric

index	size	packaging		EAN
80106	8/M	bag	12/240	5 903076 906526
80107	9/L	bag	12/240	5 903076 906533
80108	10/XL	bag	12/240	5 903076 906540
80109	11/XXL	bag	12/240	5 903076 906557
80111	8/M	blister	12/240	5 903076 906564
80112	9/L	blister	12/240	5 903076 906571
80113	10/XL	blister	12/240	5 903076 906588
80114	11/XXL	blister	12/240	5 903076 906595



Protective gloves IDOL FY55

- Foamed latex coating
- Lightweight and comfortable to wear
- Polyester fabric

index	size	packaging		EAN
80166	8/M	bag	12/240	5 903076 906793
80167	9/L	bag	12/240	5 903076 906809
80168	10/XL	bag	12/240	5 903076 906816
80169	11/XXL	bag	12/240	5 903076 906823
80172	8/M	blister	12/240	5 903076 906830
80173	9/L	blister	12/240	5 903076 906847
80174	10/XL	blister	12/240	5 903076 906854
80175	11/XXL	blister	12/240	5 903076 906861



Protective gloves IDOL FA75

- Smooth latex coating + latex foam
- Waterproof
- Polyester fabric



index	size	packaging		EAN
80161	9/L	blister	12/120	5 903076 906779
80162	10/XL	blister	12/120	5 903076 906786

Protective gloves IDOL DH95

- Crinkle latex coating
- Highest quality protection
- High-quality cotton

index	size	packaging		EAN
80147	9/L	blister	12/120	5 903076 906731
80148	10/XL	blister	12/120	5 903076 906748
80149	11/XXL	blister	12/120	5 903076 906755



Protective gloves IDOL FV90

- Durable latex foam
- Thick terry cloth
- Comfort when working in cold conditions



index	size	packaging		EAN
80152	10/XL	blister	12/120	5 903076 906762



Protective gloves IDOL PW30

- Durable polyurethane coating
- Thin, high-precision glove
- Polyester fabric

index	size	packaging		EAN
80177	8/M	bag	12/240	5 903076 906878
80178	9/L	bag	12/240	5 903076 906885
80179	10/XL	bag	12/240	5 903076 906892
80180	11/XXL	bag	12/240	5 903076 906908
80182	8/M	blister	12/240	5 903076 906915
80183	9/L	blister	12/240	5 903076 906922
80184	10/XL	blister	12/240	5 903076 906939
80185	11/XXL	blister	12/240	5 903076 906946





Protective gloves IDOL PK35

- Durable polyurethane coating
- Thin, high-precision glove
- Polyester fabric

index	size	packaging		EAN
80206	8/M	bag	12/240	5 903076 910684
80207	9/L	bag	12/240	5 903076 910691
80208	10/XL	bag	12/240	5 903076 910707
80209	11/XXL	bag	12/240	5 903076 910714
80211	8/M	blister	12/240	5 903076 910738
80212	9/L	blister	12/240	5 903076 910745
80213	10/XL	blister	12/240	5 903076 910752
80214	11/XXL	blister	12/240	5 903076 910769



Protective gloves IDOL CR50

- Crinkle latex coating
- Polyester fabric

index	size	packaging		EAN
80100	7/S	bag	12/240	5 903076 912985
80101	8/M	bag	12/240	5 903076 906489
80102	9/L	bag	12/240	5 903076 906496
80103	10/XL	bag	12/240	5 903076 906502
80104	11/XXL	bag	12/240	5 903076 906519
80115	8/M	bag with tag	12/240	5 903076 911957
80116	9/L	bag with tag	12/240	5 903076 911964
80117	10/XL	bag with tag	12/240	5 903076 911971
80118	11/XXL	bag with tag	12/240	5 903076 911988



Protective gloves IDOL LB58

- Durable latex coating
- Double protective coating
- Thin, high-precision glove
- Polyester fabric

index	size	packaging		EAN
80191	7/S	bag	12/120	5 903076 908490
80192	8/M	bag	12/120	5 903076 908506
80193	9/L	bag	12/120	5 903076 908513
80194	10/XL	bag	12/120	5 903076 908520
80195	11/XXL	bag	12/120	5 903076 908537

■ **Protective gloves IDOL DL80**

- Crinkle latex coating
- Basic protection
- Breathable natural cotton fabric

index	size	packaging		EAN
80136	8/M	bag	12/240	5 903076 906687
80137	9/L	bag	12/240	5 903076 906694
80138	10/XL	bag	12/240	5 903076 906700
80139	11/XXL	bag	12/240	5 903076 906717



■ **Protective nitrile gloves IDOL STANDARD**

- Powder-free
- Tear-resistant

index	size	packaging		EAN
80226	8-9/L	box	50	5 903076 913449
80227	9-10/XL	box	50	5 903076 913456
80228	10-11/XXL	box	50	5 903076 913463
80231	8-9/L	box	10	5 903076 913470
80232	9-10/XL	box	10	5 903076 913487
80233	10-11/XXL	box	10	5 903076 913494



■ **Protective nitrile gloves IDOL POWER**

- Thick and durable
- Powder-free
- Extended cuff





index	size	packaging		EAN
80236	8-9/L	box	50	5 903076 913500
80237	9-10/XL	box	50	5 903076 913517
80238	10-11/XXL	box	50	5 903076 913524
80241	8-9/L	blister	10	5 903076 913531
80242	9-10/XL	blister	10	5 903076 913548
80243	10-11/XXL	blister	10	5 903076 913555





■ **Protective gloves IDOL Perfect Garden**





- Durable and thick latex foam
- Structured for improved grip
- Nylon + spandex fabric – perfect fit

index	size	packaging		EAN
80215	6/XS	blister	12/120	5 903076 911643 
80216	7/S	blister	12/120	5 903076 911650 
80217	8/M	blister	12/120	5 903076 911667 



■ **Protective gloves IDOL White Garden**





- Durable polyurethane coating
- Thin, high-precision glove
- Polyester fabric

index	size	packaging		EAN
80221	6/XS	blister	12/240	5 903076 913289 
80222	7/S	blister	12/240	5 903076 913296 
80223	8/M	blister	12/240	5 903076 913302 



■ **Protective gloves IDOL Green Garden**

- Durable nitrile coating
- Precise grip
- Polyester fabric

index	size	packaging		EAN
80218	6/XS	blister	12/240	5 903076 913258 
80219	7/S	blister	12/240	5 903076 913265 
80220	8/M	blister	12/240	5 903076 913272 

WORK COVERALLS AND FLEECES





Protective suit Basic

- Lightweight and comfortable
- Protects against dust and minor splashes
- Elastic cuffs and hood
- Easy to put on - practical zipper

index	size		EAN
81001	L	25	5 903076 910011
81002	XL	25	5 903076 910028
81003	XXL	25	5 903076 910035
81004	XXXL	25	5 903076 910042



Cat. I



Protective suit Flex

- Perfect for insulation and insulation work
- Breathable - comfortable even during long periods of work
- Flexible and comfortable - adapts to your movements
- Easy to put on - practical zipper

index	size		EAN
81006	L	50	5 903076 910066
81007	XL	50	5 903076 910073
81008	XXL	50	5 903076 910080
81009	XXXL	50	5 903076 910097



Cat. II
0624



EN 13034:2005+A1:2009
Protection against liquid chemical, light spray (type 6)



EN ISO 13982-1:2004+A1:2010
Protection against airborne solid particulates (type 5)



EN 1149-5:2018
Electrostatic charges

EN ISO 13688:2013
+A1:2021
Protective clothing - general requirements



Protective suit Paint Pro

- Splash-resistant - ideal for painting and varnishing
- Durable
- Elastic cuffs and hood
- Easy to put on - practical zipper

index	size		EAN
81011	L	50	5 903076 910110
81012	XL	50	5 903076 910127
81013	XXL	50	5 903076 910134
81014	XXXL	50	5 903076 910141



Cat. III
0624



EN 13034:2005+A1:2009
Protection against liquid chemical, light spray (type 6)



EN ISO 13982-1:2004+A1:2010
Protection against airborne solid particulates (type 5)



EN 14325:2004
Protection against chemicals

EN ISO 13688:2013
+A1:2021
Protective clothing - general requirements



EN 1073-2:2002
Protection against radioactive contamination



EN 14126:2003+AC:2004
Protection against infective agents



EN 1149-5:2018
Electrostatic charges

■ Dust mask with valve (3 pcs.)

KLASA
FFP1

index		EAN
5707	100	5 906554 511762



■ Fleece Professional

- Material weight: 280 g
- Reinforced elbow patches
- Adjustable velcro cuffs

index	size		EAN
9404	S	10	5 903076 906434
9405	M	10	5 903076 906441
9406	L	10	5 903076 906458
9407	XL	10	5 903076 906465
9408	XXL	10	5 903076 906472



■ Fleece Standard

- Light and comfortable
- Material weight: 280 g

index	size		EAN
9399	S	10	5 903076 906427
9400	M	10	5 903076 901996
9401	L	10	5 903076 902009
9402	XL	10	5 903076 902016
9403	XXL	10	5 903076 902023





MARKERS AND PENCILS

■ **Thin construction marker**

- Waterproof, quick-drying
- Permanent, precise tip
- Highly efficient



index	tip		EAN
6687	precise 1,0 mm	12	 5 903076 908049

■ **Thick construction marker**

- Waterproof, quick-drying
- Permanent
- Highly efficient



index	tip		EAN
6689	chisel 1-5 mm	12	 5 903076 908063

Construction marker for holes

- Waterproof, quick-drying
- Thin, long tip

index	tip		EAN
6688	needle-shaped 0,6 mm	12	5 903076 908056



Thin permanent marker

- Very intense, long-lasting ink
- For most surfaces
- Quick-drying
- Precise, fine tip

index	tip	color		EAN
6690	round 1,0 mm	● black	12	5 903076 908070
6691	round 1,0 mm	● blue	12	5 903076 908087
6692	round 1,0 mm	● red	12	5 903076 908094
6693	round 1,0 mm	● green	12	5 903076 908100



Thick permanent marker

- Very intense, long-lasting ink
- For most surfaces
- Quick-drying
- Thick tip

index	tip	color		EAN
6694	round 1,5 mm	● black	12	5 903076 908117
6695	round 1,5 mm	● blue	12	5 903076 908124
6696	round 1,5 mm	● red	12	5 903076 908308
6697	round 1,5 mm	● green	12	5 903076 908315





Thin oil marker

Oil-based marker with a 1,5 mm thick round fiber tip.
Quick-drying and waterproof oil-based ink

index	color		EAN
6671	● black	12	5 903076 907967
6672	○ white	12	5 903076 907974
6673	● blue	12	5 903076 907981
6674	● red	12	5 903076 907998
6675	● green	12	5 903076 908001
6676	● yellow	12	5 903076 908018



Thick oil marker

Oil-based marker with a 2,5 mm round fiber tip.
Quick-drying and waterproof oil-based ink

index	color		EAN
6677	● black	12	5 903076 908025
6678	○ white	12	5 903076 908032



Double-sided thin marker

- Very intense, long-lasting ink
- For most surfaces
- Quick-drying
- Two tips: needle-shaped 0,6 mm and round 1,0 mm





index	color		EAN
6698	● black	12	5 903076 911728

■ Mechanical pencil

index	set		EAN
6684	pencil + 6 refills	12	 5 903076 907288
6685	refills (3 colors)	20	 5 903076 907295



■ Construction pencil

index	hardness	color		EAN
6680	HB	 green	50	 5 903076 907264
6681	6H	 red	50	 5 903076 907271

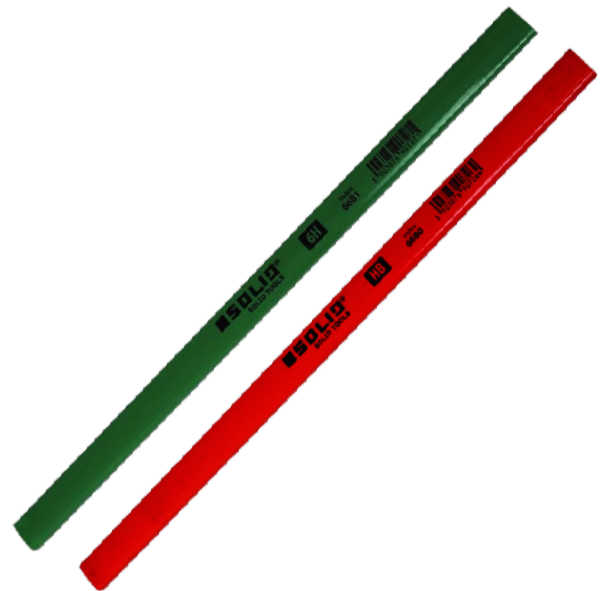

■ Construction pencil sharpener

index		EAN
6679	40	 5 903076 910158





BLACK TIGER

ORIGINAL

DURABLE

UTILITY KNIVES

AND BLADES

BLACK TIGER SERIES

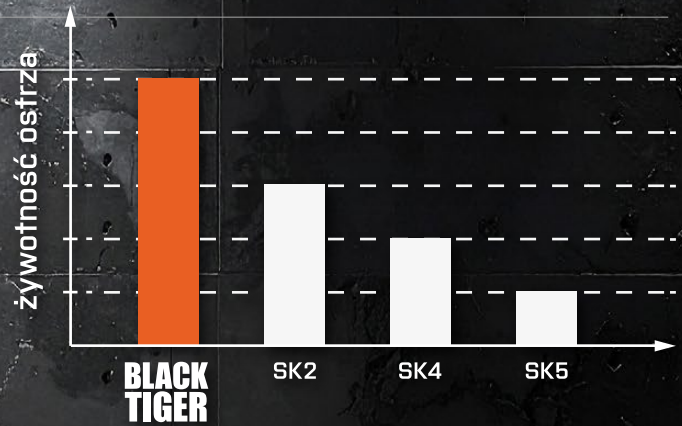

Blade Black Tiger STANDARD

BLACK TIGER SERIES

index	blade width	thickness	packaging	☰	EAN
6476B	9 mm	0,4 mm	blister	10	5 903076 902395
5669	18 mm	0,5 mm	box	10	5 903076 909282
5669B	18 mm	0,5 mm	blister	10	5 903076 909305
6477B	25 mm	0,7 mm	blister	10	5 903076 900401

40% THICKER



0,7 mm





Blade Black Tiger 40% THICKER

BLACK TIGER SERIES

index	blade width	thickness	packaging	☰	EAN
6475	18 mm	0,7 mm	box	10	5 903076 902979
6475B	18 mm	0,7 mm	blister	10	5 903076 900760

■ **Blade Black Tiger FLEXIBLE**

BLACK TIGER SERIES

index	blade width	thickness	packaging		EAN
6474B	12,5 mm	0,2 mm	blister	12	 5 903076 900753



FLEXIBLE BLADE





0,2 mm





■ **Blade for the trapezoidal knife Black Tiger**

BLACK TIGER SERIES

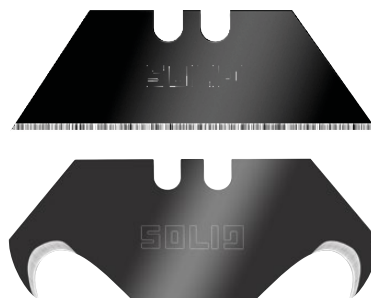
index	thickness	type	packaging		EAN
6478B	0,5 mm	trapezoidal	blister	10	 5 903076 900418
6479B	0,5 mm	hook	blister	10	 5 903076 900425



■ **Snap-off blade**

index	blade width	type		EAN
5930	18 mm	black, SK5	20	 5 903076 900203



■ **Snap-off blade**

index	blade width	type		EAN
5650	18 mm	standard, SK5	10	 5 906554 512721



■ Composite knife with 2 spare blades

BLACK TIGER SERIES

1+2 DODATKOWE OSTRZA



index	blade width	packaging		EAN
6487	18 mm	box	24	5 903076 900883
6487B	18 mm	blister	10	5 903076 900890

■ Flat composite knife

BLACK TIGER SERIES



index	blade width	packaging		EAN
6480	18 mm	box	24	5 903076 900432
6480B	18 mm	blister	10	5 903076 900449

■ Rubberized flat metal knife

BLACK TIGER SERIES



index	blade width	packaging		EAN
6482	18 mm	box	24	5 903076 900729
6482B	18 mm	blister	12	5 903076 900654

■ Rubberized metal knife



BLACK TIGER SERIES



index	blade width	packaging		EAN
6481	18 mm	box	24	5 903076 900722
6481B	18 mm	blister	12	5 903076 900630

Rubberized metal knife



BLACK TIGER SERIES

index	blade width	packaging		EAN
5684	18 mm	box	24	 5 903076 909329
5684B	18 mm	blister	12	 5 903076 909343



Metal knife



BLACK TIGER SERIES

index	blade width	packaging		EAN
5639	18 mm	box	24	 5 906554 512967
5639B	18 mm	blister	12	 5 903076 909183



Rubberized plastic knife



BLACK TIGER SERIES

index	blade width	packaging		EAN
5642	18 mm	box	24	 5 906554 512320
5642B	18 mm	blister	12	 5 903076 909251



Plastic knife

BLACK TIGER SERIES

index	blade width	packaging		EAN
5641	18 mm	box	24	 5 906554 512714
5641B	18 mm	blister	12	 5 903076 909220



■ Plastic knife with a metal tail

BLACK TIGER SERIES





index	blade width	packaging		EAN
5683B	18 mm	blister	12	 5 903076 905123

■ Rubberized plastic knife

BLACK TIGER SERIES



index	blade width	packaging		EAN
6484B	25 mm	blister	12	 5 903076 900682

■ Knife COLORS

SK5 blade





index	blade width	color	packaging		EAN
5670	18 mm		box	24	 5 906554 518730

■ Metal knife

BLACK TIGER SERIES



index	blade width	packaging		EAN
6483B	9 mm	blister	12	 5 903076 900685

■ Knife with a flexible blade

BLACK TIGER SERIES

index	blade width	packaging		EAN
6486B	12,5 mm	blister	12	 5 903076 900777



FLEXIBLE BLADE



0,2 mm

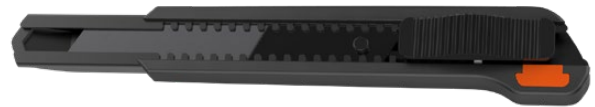

■ Rubberized trapezoidal metal knife

BLACK TIGER SERIES



index	packaging		EAN
6485B	blister	12	 5 903076 900708

1+2 EXTRA BLADES



■ Metal trapezoidal knife

BLACK TIGER SERIES

index	packaging		EAN
5685B	blister	12	 5 903076 909367

CHOOSE THE MATCHING BLADES



Trapezoidal blades
Black Tiger

index 6478B p. 31



Hook blades
Black Tiger

index 6479B p. 31



■ Wool and styrofoam knife

index		EAN
6380	12	 5 906554 519386





■ Paint scraper BLACK TIGER

index		EAN
5636	10	5 903076 910592

CHOOSE THE MATCHING BLADES



Blade Black Tiger

index **5669** p. 30



**Blade Black Tiger
40% thicker**

index **6475** p. 30

■ Drywall saw



index		EAN
5635	10	5 903076 906984

■ Wallpaper knife



index	blade width	packaging		EAN
5640	18 mm	box	24	5 906554 513032

■ Paint scraper









index		EAN
5638	10	5 906554 513414



TAPES

Measure tape Gold



Reliable mechanism, non-slip rubber casing

index	length / width	packaging		EAN
6445	3 m / 16 mm	box	12	 5 903076 907387
6445B	3 m / 16 mm	blister	12	 5 903076 907394
6446	5 m / 19 mm	box	12	 5 903076 900272
6446B	5 m / 19 mm	blister	12	 5 903076 900289
6447	7,5 m / 25 mm	box	6	 5 903076 907400
6447B	7,5 m / 25 mm	blister	6	 5 903076 907417



Measure tape Master







Reliable mechanism, 25% stiffer strap, non-slip rubber casing

index	length / width	packaging		EAN
6443	5 m / 25 mm	box	12	 5 903076 900258
6443B	5 m / 25 mm	blister	12	 5 903076 900265



Measure tape Magneto

Neodymium magnet, double lock, reliable mechanism

index	length / width	packaging		EAN
6420	3 m / 19 mm	box	12	 5 903076 909428
6420B	3 m / 19 mm	blister	12	 5 903076 900081
6421	5 m / 25 mm	box	12	 5 903076 909435
6421B	5 m / 25 mm	blister	12	 5 903076 900098
6422	10 m / 25 mm	box	6	 5 903076 909442
6442B	10 m / 25 mm	blister	6	 5 903076 900104





■ **Measure tape Glass**

The rubber tip prevents scratching tiles and glass, reliable mechanism

index	length / width	packaging		EAN
6448	5 m / 19 mm	box	12	5 903076 900296
6448B	5 m / 19 mm	blister	12	5 903076 900302



■ **Measure tape Auto-Hold**

Anti-slip rubber casing, automatic tape lock (reverse brake), reliable mechanism

index	length / width	packaging		EAN
6423	3 m / 16 mm	box	12	5 903076 909459
6424	5 m / 25 mm	box	6	5 903076 909466



■ **Measure tape Expert**

Rubber casing, reliable mechanism, double lock

index	length / width	packaging		EAN
6439	3 m / 16 mm	box	12	5 903076 900234
6440	5 m / 19 mm	box	6	5 903076 900241



■ **Measure tape Compact**

Compact size, reliable reinforced mechanism

index	length / width	packaging		EAN
5620	3 m / 16 mm	box	12	5 906554 518297
5621	5 m / 19 mm	box	12	5 906554 518303
5622	8 m / 25 mm	box	12	5 906554 518310



■ Folding wooden rule

index	length		EAN
6433	1 m	12	 5 903076 900661
6434	2 m	12	 5 903076 900678



■ Telescopic support pole



- maximum load at 90 degrees – 30 kg
- maximum load at 65 degrees – 15 kg
- rubber and anti-slip feet
- quick release system

index	length	load capacity		EAN
6534	50 – 115 cm	30 kg	2	 5 903076 910578
6535	115 – 290 cm	30 kg	2	 5 903076 910585



■ Telescopic support pole

- maximum load at 90 degrees – 60 kg
- maximum load at 65 degrees – 20 kg
- rubber and anti-slip feet
- quick release system

index	length	load capacity		EAN
6532	75 – 125 cm	60 kg	4	 5 903076 910554
6533	160 – 290 cm	60 kg	4	 5 903076 910561



PAINTING ACCESSORIES



■ Flat paint brush Professional Series



index	size	📦	EAN
6565	1"	12	5 903076 909718
6566	1,5"	12	5 903076 909725
6567	2"	12	5 903076 909732
6568	2,5"	12	5 903076 909749
6569	3"	6	5 903076 909756

■ Flat paint brush Elite



index	size	📦	EAN
6592	30 mm	6	5 903076 910165
6593	40 mm	6	5 903076 910172
6594	50 mm	6	5 903076 910189
6595	60 mm	6	5 903076 910196
6596	70 mm	6	5 903076 910202

■ Flat paint brush Olejny

index	size	☒	EAN
6572	20 mm	24	5 903076 907325
6555	30 mm	12	5 906554 511328
6556	40 mm	12	5 906554 511915
6557	50 mm	12	5 906554 512363
6558	60 mm	12	5 906554 512394
6559	70 mm	12	5 906554 512707
6573	90 mm	12	5 903076 907332



■ Flat paint brush Lazur

index	size	☒	EAN
6560	30 mm	12	5 906554 513025
6561	40 mm	12	5 906554 513629
6562	50 mm	12	5 906554 514664
6563	60 mm	12	5 906554 514695
6564	70 mm	12	5 906554 514701



■ Flat paint brush Akryl

index	size	☒	EAN
6550	30 mm	12	5 906554 510079
6551	40 mm	12	5 906554 510086
6552	50 mm	12	5 906554 510116
6553	60 mm	12	5 906554 511236
6554	70 mm	12	5 906554 511243



■ Flat paint brush Orange

index	size	☒	EAN
6700	1"	6	5 903076 907905
6701	1,5"	6	5 903076 907912
6702	2"	6	5 903076 907929
6703	2,5"	6	5 903076 907936
6704	3"	6	5 903076 907943
6705	4"	6	5 903076 907950



■ Flat paint brush Wood Expert



index	size	📦	EAN
6730	1"	6	5 903076 911520
6731	1,5"	6	5 903076 911537
6732	2"	6	5 903076 911544
6733	2,5"	6	5 903076 911551
6734	3"	6	5 903076 911568
6735	4"	6	5 903076 911575

■ Angled paint brush Syntetyk



index	size	📦	EAN
6588	1,5"	12	5 903076 907578
6589	2"	12	5 903076 907585
6590	2,5"	12	5 903076 907592
6591	3"	12	5 903076 907608

■ Flat paint brush Syntetyk



index	size	📦	EAN
6582	1"	12	5 903076 907516
6583	1,5"	12	5 903076 907523
6584	2"	12	5 903076 907530
6585	2,5"	12	5 903076 907547
6586	3"	12	5 903076 907554
6587	4"	12	5 903076 907561

■ Flat paint brush



index	size	📦	EAN
5204	1"	12	5 906554 510673
5205	1,5"	12	5 906554 510680
5206	2"	12	5 906554 510697
5207	2,5"	12	5 906554 510703
5208	3"	6	5 906554 510710
5209	3,5"	6	5 906554 510727
5210	4"	6	5 906554 510734

■ Flat paint brush

index	size	☰	EAN
5200	1"	12	5 906554 513056
5201	1,5"	12	5 906554 513063
5202	2"	12	5 906554 513070
5203	2,5"	12	5 906554 513087



■ Radiator paint brush Professional Series

index	size	☰	EAN
6574	1,5" / 36 mm	6	5 903076 901156
6575	2" / 50 mm	6	5 903076 901163
6576	2,5" / 63 mm	6	5 903076 901170



■ Radiator paint brush

index	size	☰	EAN
5211	1"	12	5 906554 510741
5212	1,5"	12	5 906554 510758
5213	2"	12	5 906554 510765
5214	2,5"	12	5 906554 510772



■ Round paint brush

index	size	☰	EAN
5215	20 mm	12	5 906554 510789
5216	25 mm	12	5 906554 510796
5217	30 mm	12	5 906554 510802
5218	35 mm	12	5 906554 510819
5219	40 mm	6	5 906554 510826
5220	45 mm	6	5 906554 510833
5221	50 mm	12	5 906554 510840
5222	55 mm	12	5 906554 510857
5223	60 mm	12	5 906554 510864
5224	70 mm	12	5 906554 510871











■ Block paint brush Professional Series

index	size		EAN
6570	120 mm	6	 5 903076 909763
6571	150 mm	6	 5 903076 909770



■ Block paint brush

index	size		EAN
5227	110 mm	10	 5 906554 510901
5228	130 mm	10	 5 906554 510918
5229	140 mm	10	 5 906554 510925
5230	150 mm	10	 5 906554 510932
5225	70 mm	10	 5 906554 510888
5226	90 mm	10	 5 906554 510895







■ Block paint brush

index	size		EAN
5231	170 mm	12	 5 906554 510949
5232	180 mm	12	 5 906554 510956
5233	190 mm	12	 5 906554 510963



■ Spalter paint brush



index	size		EAN
6736	80 mm	6	 5 903076 913616
6737	100 mm	6	 5 903076 913623
6738	120 mm	6	 5 903076 913630
6739	150 mm	6	 5 903076 913647

■ Ceiling brush

index		EAN
5238	48	 5 906554 511014





■ Pitch brush

index		EAN
5239	40	 5 906554 511021



Beech handle for pitch brush

index	size	diameter	type		EAN
5782	150 cm	21 mm	smooth	25	 5 902891 286929

■ Paint brushes 5 pieces

index		EAN
6549	12	 5 903076 911995



■ Pinstriping brushes 4 pieces

index	size		EAN
5726	6, 8, 10, 12 mm	12	 5 903076 912925



PAINTING ROLLER HANDLE

WITH EXTENSION CLICK POLE

 **EUIPO**
EUROPEAN UNION
INTELLECTUAL PROPERTY OFFICE
REGISTERED DESIGN

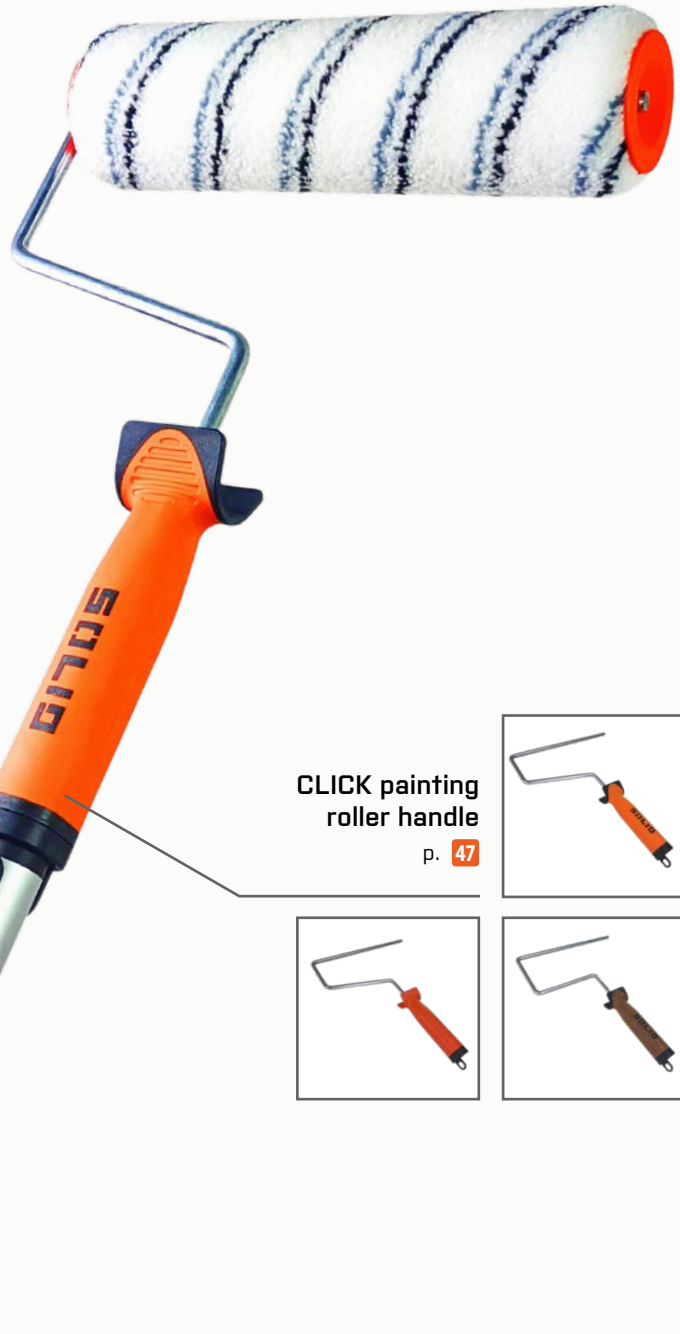

Reliable, heavy-duty
CLICK mounting system



CLICK extension pole
p. 47

CLICK painting
roller handle
p. 47

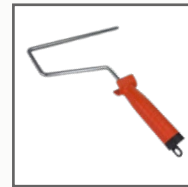

FAST INSTALLATION

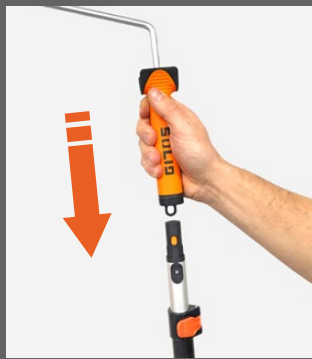

EASY DISASSEMBLY

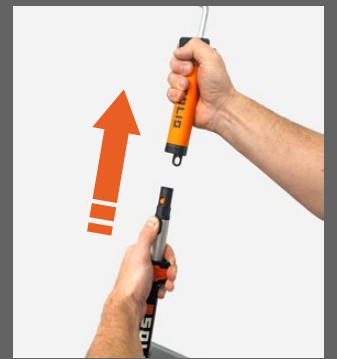

Paint roller handle Premium



index	size	diameter		EAN
6608	Maxi 18 cm	Ø 8 mm	10	5 903076 905215
6609	Maxi 25 cm	Ø 8 mm	10	5 903076 905222

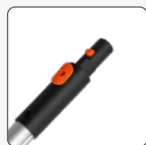

CHOOSE THE MATCHING SET

Extension pole with CLICK

index **6597, 6598, 6599** p. 47



CLICK

Paint roller handle Premium Korek



index	size	diameter		EAN
6610	Maxi 18 cm	Ø 8 mm	10	5 903076 905284
6611	Maxi 25 cm	Ø 8 mm	10	5 903076 905291

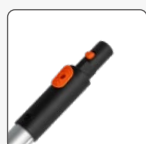

CHOOSE THE MATCHING SET

Extension pole with CLICK

index **6597, 6598, 6599** p. 47



CLICK

Paint roller handle



index	size	diameter		EAN
6600	Mini 6 cm	Ø 6 mm	10	5 903076 905130
6601	Medium 10 cm	Ø 6 mm	10	5 903076 905147
6602	Long 10 cm	Ø 6 mm	10	5 903076 905154
6603	Maxi 18 cm	Ø 8 mm	10	5 903076 905161
6604	Maxi 25 cm	Ø 8 mm	10	5 903076 905178



CLICK

Extension pole CLICK







index	size		EAN
6597	0,5 - 1,2 m	6	5 903076 905369
6598	1,0 - 1,8 m	6	5 903076 905376
6599	1,0 - 2,7 m	6	5 903076 905383



CLICK









■ Paint roller handle 2K

index	size	diameter		EAN
5290	Maxi 18 cm	Ø 8 mm	10	 5 906554 519140
5291	Maxi 25 cm	Ø 8 mm	10	 5 906554 519157
5297	Maxi 36 cm	Ø 8 mm	10	 5 906554 511908
5298	Maxi 46 cm	Ø 8 mm	10	 5 906554 513667





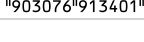



■ Paint roller handle

index	size	diameter		EAN
6627	Mini 6 cm	Ø 6 mm	10	 5 903076 913340
6628	Medium 10 cm	Ø 6 mm	10	 5 903076 913357
6629	Long 10 cm	Ø 6 mm	10	 5 903076 913364
6630	Maxi 18 cm	Ø 8 mm	10	 5 903076 913371
6631	Maxi 25 cm	Ø 8 mm	10	 5 903076 913388
6632	Maxi 36 cm	Ø 8 mm	10	 5 903076 913395
6633	Maxi 46 cm	Ø 8 mm	10	 5 903076 913401



■ Paint roller handle

index	size	diameter		EAN
5300	Mini 6 cm	Ø 6 mm	70	 5 906554 511854
5301	Medium 10 cm	Ø 6 mm	25	 5 906554 511861
5302	Long 10 cm	Ø 6 mm	100	 5 906554 511878
5299	Maxi 15 cm	Ø 6 mm	50	 5 906554 513049
5303	Maxi 18 cm	Ø 8 mm	30	 5 906554 511564
5304	Maxi 25 cm	Ø 8 mm	25	 5 906554 511571



■ Adjustable painting roller handle

For paint rollers from 30 cm to 50 cm wide

index	size		EAN
6235	30 - 50 cm	30	 5 903076 911254

Aluminum extension pole

index	size		EAN
6500	1 - 1,8 m	12	 5 903076 900838
6501	1,5 - 3 m	12	 5 903076 900845



Extension pole

index	size		EAN
5311	1 - 1,8 m	12	 5 906554 511830
5312	1,5 - 3 m	12	 5 906554 511847



Steel extension pole REDSHARK

Aluminum thread; steel construction

index	size		EAN
6502	0,6 - 1,0 m	64	 5 903076 912756
6503	1,0 - 1,8 m	42	 5 903076 912763
6504	1,5 - 2,8 m	30	 5 903076 912770



Aluminum extension pole REDSHARK

Patented thread; aluminum construction

index	size		EAN
6505	0,6 - 1,2 m	36	 5 903076 912787
6506	1,0 - 1,8 m	25	 5 903076 912794





■ Paint tray 1 pc.
+ 3 replacement liners

 **EUIPO**
EUROPEAN UNION
INTELLECTUAL PROPERTY OFFICE
REGISTERED DESIGN

index	size	roller		EAN
6714	16 × 31 cm	11 cm	13	5 903076 903839
6715	27 × 41 cm	18 cm	8	5 903076 903846
6716	34 × 41 cm	25 cm	8	5 903076 903853



■ Paint tray SOLID

 **EUIPO**
EUROPEAN UNION
INTELLECTUAL PROPERTY OFFICE
REGISTERED DESIGN

index	size	roller		EAN
5307	11 × 24 cm	8 cm	25	5 906554 511793
5308	16 × 31 cm	11 cm	20	5 906554 511809
5309	27 × 41 cm	18 cm	10	5 906554 511816
5310	34 × 41 cm	25 cm	10	5 906554 511823



CHOOSE THE RIGHT SET

Replacement liners for paint tray

index **6711, 6712, 6713** p. 50





■ Replacement liners
for paint tray SOLID

 **EUIPO**
EUROPEAN UNION
INTELLECTUAL PROPERTY OFFICE
REGISTERED DESIGN



index	size	roller		EAN
6711	16 × 31 cm	11 cm	30	5 903076 903891
6712	27 × 41 cm	18 cm	30	5 903076 903907
6713	34 × 41 cm	25 cm	30	5 903076 903914

■ Paint tray SOLID + liner

index	size	roller		EAN
6720	39 × 55 cm	46 cm	10	 5 903076 912725



■ Liner for paint tray SOLID

index	size	roller		EAN
6721	39 × 55 cm	46 cm	10	 5 903076 912732





■ Painting pail + liner

index	capacity		EAN
6617	1.2 l	6	 5 903076 911889



■ Liner for painting pail



index	capacity		EAN
6618	1.2 l	12	 5 903076 911896



 **NAJLEPSZA CENA**



■ **Paint tray ECO**

index	size	roller		EAN
5293	24 × 35 cm	18 cm	10	 5 906554 512929
5294	32 × 36 cm	25 cm	10	 5 906554 512936





CHOOSE THE RIGHT SET

Replacement liners for paint tray

index **6711, 6712, 6713** p. 50







■ **Replacement liners for paint tray ECO**

index	size	roller		EAN
5909	32 × 36 cm	25 cm	30	 5 903076 908971



■ **Paint tray 1 pc.
+ 3 replacement liners**





 **EUIPO**
EUROPEAN UNION
INTELLECTUAL PROPERTY OFFICE
REGISTERED DESIGN

index	size	roller		EAN
6717	16 × 31 cm	11 cm	13	 5 903076 903860
6718	27 × 41 cm	18 cm	8	 5 903076 903877
6719	34 × 41 cm	25 cm	8	 5 903076 903884



■ **Paint tray SOLID**

 **EUIPO**
EUROPEAN UNION
INTELLECTUAL PROPERTY OFFICE
REGISTERED DESIGN

index	size	roller		EAN
5295	11 × 24 cm	8 cm	25	 5 906554 516057
5292	16 × 31 cm	11 cm	20	 5 906554 512912
6709	27 × 41 cm	18 cm	10	 5 903076 903792
6710	34 × 41 cm	25 cm	10	 5 903076 903808



CHOOSE THE RIGHT SET

Replacement liners for paint tray

index **6711, 6712, 6713** p. 50

■ Paint grid

index	size		EAN
5315	22 / 26 cm	150	 5 906554 513506
5306	27 / 30 cm	100	 5 906554 511786

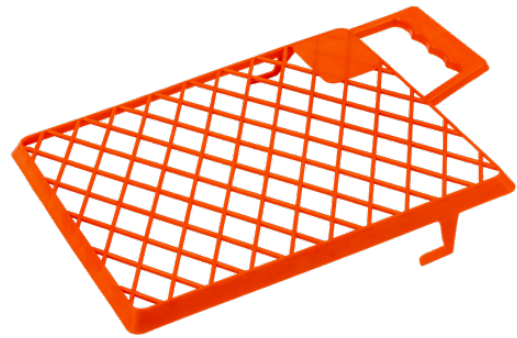

■ Paint grid

index	size		EAN
5318	22 / 26 cm	100	 5 906554 516699
5319	27 / 30 cm	100	 5 906554 516705



■ Metal paint grid

index	size		EAN
5314	26 / 30 cm	50	 5 906554 513315

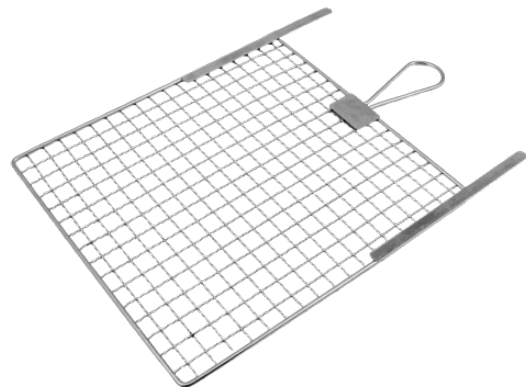

■ Paint bucket

index	size		EAN
5316	8 l	20	 5 906554 513513
5313	12 l	20	 5 906554 511885



PAINT ROLLERS AND SETS



■ Paint roller Black Silver

Fabric: polyamide

Intended use: latex, ceramic, acrylic, and emulsion paints



index	size	diameter	pile length		EAN
for smooth surfaces					
5750	Mini 7 cm (2-pack)	Ø 16	10 mm	10	5 906554 518457
5751	Mini 10 cm (2-pack)	Ø 16	10 mm	10	5 906554 518464
5752	Mini 15 cm (2-pack)	Ø 16	10 mm	10	5 906554 518471
5753	Midi 10 cm	Ø 30	10 mm	10	5 906554 518488
5746	Midi 15 cm	Ø 30	10 mm	10	5 906554 519645
5761	Maxi 18 cm	Ø 48	10 mm	10	5 906554 518563
5762	Maxi 25 cm	Ø 48	10 mm	10	5 906554 518570
5763	Maxi 36 cm	Ø 48	10 mm	10	5 903076 912886
5749	Maxi 46 cm	Ø 48	10 mm	10	5 906554 518440

■ Paint roller Microfiber

Fabric: microfiber

Intended use: emulsion paints, latex paints, stains, varnishes, primers



index	size	diameter	pile length		EAN
for smooth surfaces					
5744	Mini 6 cm (2-pack)	Ø 16	6 mm	10	5 906554 519911
5758	Mini 10 cm (2-pack)	Ø 16	6 mm	10	5 906554 518532
5759	Mini 15 cm (2-pack)	Ø 16	6 mm	10	5 906554 518549
5760	Midi 10 cm	Ø 30	10 mm	10	5 906554 518556
5745	Midi 15 cm	Ø 30	10 mm	10	5 906554 519638
5756	Maxi 18 cm	Ø 48	10 mm	10	5 906554 518518
5757	Maxi 25 cm	Ø 48	10 mm	10	5 906554 518525
5797	Maxi 36 cm	Ø 48	10 mm	10	5 903076 913715
5798	Maxi 46 cm	Ø 48	10 mm	10	5 903076 913722

Paint roller Assassin

Fabric: polyacrylic

Intended use: emulsion and acrylic paints

index	size	diameter	pile length	⊞	EAN
for rough surfaces					
5788	Mini 7 cm (2-pack)	Ø 16	10 mm	10	5 903076 912893
5789	Mini 10 cm (2-pack)	Ø 16	10 mm	10	5 903076 912909
5790	Mini 15 cm (2-pack)	Ø 16	10 mm	10	5 906554 519249
5791	Midi 10 cm	Ø 30	10 mm	10	5 906554 519256
5792	Midi 15 cm	Ø 30	10 mm	10	5 906554 519263
5793	Maxi 18 cm	Ø 48	12 mm	10	5 906554 519270
5794	Maxi 25 cm	Ø 48	12 mm	10	5 906554 519287
5795	Maxi 36 cm	Ø 48	12 mm	10	5 906554 519294
5796	Maxi 46 cm	Ø 48	12 mm	10	5 903076 912916



Paint roller Microlon

Fabric: Microlon

Intended use: Latex, ceramic, acrylic, and emulsion paints

index	size	diameter	pile length	⊞	EAN
for rough surfaces					
6751	Mini 10 cm (2-pack)	Ø 16	14 mm	10	5 903076 913654
6752	Midi 10 cm	Ø 30	14 mm	10	5 903076 913661
6753	Maxi 18 cm	Ø 48	18 mm	10	5 903076 913678
6754	Maxi 25 cm	Ø 48	18 mm	10	5 903076 913685
6755	Maxi 36 cm	Ø 48	18 mm	10	5 903076 913692
6756	Maxi 46 cm	Ø 48	18 mm	10	5 903076 913708



Paint roller Microfiber Long

Fabric: Microfiber

Intended use: Acrylic paints, primers, stains (including all facade paints in the facade roller variant)

index	size	diameter	pile length	⊞	EAN
for rough surfaces					
5925	Mini 7 cm (2-pack)	Ø 16	10 mm	10	5 903076 912930
5926	Mini 10 cm (2-pack)	Ø 16	10 mm	10	5 903076 912947
5927	Mini 15 cm (2-pack)	Ø 16	10 mm	10	5 903076 912954
5928	Midi 10 cm	Ø 30	10 mm	10	5 903076 912961
5929	Midi 15 cm	Ø 30	10 mm	10	5 903076 912978
5754	Maxi 18 cm	Ø 48	15 mm	10	5 906554 518495
5755	Maxi 25 cm	Ø 48	15 mm	10	5 906554 518501
5747	Facade 18 cm	Ø 68	15 mm	10	5 906554 519614
5748	Facade 25 cm	Ø 68	15 mm	10	5 906554 519621





Paint roller Syntex PRO

Fabric: polyamide

Intended use: emulsion and acrylic paints (including all facade paints in the facade roller variant)

index	size	diameter	pile length	📦	EAN
for rough surfaces					
5715	Maxi 18 cm	Ø 48	12 mm	10	5 906554 518587
5716	Maxi 25 cm	Ø 48	12 mm	10	5 906554 518594
5721	Maxi 18 cm	Ø 48	18 mm	10	5 906554 518624
5722	Maxi 25 cm	Ø 48	18 mm	10	5 906554 517627
5723	Facade 18 cm	Ø 68	18 mm	10	5 906554 517634
5724	Facade 25 cm	Ø 68	18 mm	10	5 906554 517641



Paint roller Nylon PRO

Fabric: nylon polyamide

Intended use: solvent-based varnishes, acrylic varnishes, oil paints

index	size	diameter	pile length	📦	EAN
for smooth surfaces					
5142	Mini 10 cm (2-pack)	Ø 16	13 mm	10	5 906554 512943
5143	Midi 10 cm	Ø 16	13 mm	10	5 906554 512950
5140	Maxi 18 cm	Ø 48	13 mm	10	5 906554 515166
5141	Maxi 25 cm	Ø 48	13 mm	10	5 906554 515173



Paint roller Yellow Thread

Fabric: polyacrylic

Intended use: emulsion paints, latex paints

index	size	diameter	pile length	📦	EAN
for smooth surfaces					
5193	Mini 7 cm (2-pack)	Ø 16	10 mm	10	5 906554 516200
5194	Mini 10 cm (2-pack)	Ø 16	10 mm	10	5 906554 516217
5195	Mini 15 cm (2-pack)	Ø 16	10 mm	10	5 906554 516224
5165	Midi 10 cm	Ø 30	10 mm	10	5 906554 511298
5166	Midi 15 cm	Ø 30	10 mm	10	5 906554 511304
5120	Maxi 18 cm	Ø 48	12 mm	10	5 906554 512639
5121	Maxi 25 cm	Ø 48	12 mm	10	5 906554 512646

Paint roller Bluestar

Fabric: polyester

Intended use: acrylic paints, acrylic varnishes

index	size	diameter	pile length	📦	EAN
for smooth surfaces					
5106	Maxi 18 cm	Ø 48	8 mm	10	5 906554 510437
5107	Maxi 25 cm	Ø 48	8 mm	10	5 906554 510444



Paint roller Multicolor

Fabric: polyacrylic

Intended use: emulsion and acrylic paints (including all facade paints in the facade roller variant)

index	size	diameter	pile length	📦	EAN
for rough surfaces					
5159	Mini 7 cm (2-pack)	Ø 16	10 mm	10	5 906554 511038
5186	Mini 10 cm (2-pack)	Ø 16	10 mm	10	5 906554 515241
5187	Mini 15 cm (2-pack)	Ø 16	10 mm	10	5 906554 515258
5191	Midi 10 cm	Ø 30	10 mm	10	5 906554 516187
5192	Midi 15 cm	Ø 30	10 mm	10	5 906554 516194
5108	Maxi 18 cm	Ø 48	15 mm	10	5 906554 510413
5109	Maxi 25 cm	Ø 48	15 mm	10	5 906554 510420
5138	Facade 18 cm	Ø 68	19 mm	10	5 906554 515142
5139	Facade 25 cm	Ø 68	19 mm	10	5 906554 515159



Paint roller Nylon

Fabric: nylon polyamide

Intended use: solvent-based varnishes, acrylic varnishes, oil paints

index	size	diameter	pile length	📦	EAN
for smooth surfaces					
5170	Mini 7 cm (2-pack)	Ø 16	6 mm	10	5 906554 511335
5180	Mini 10 cm (2-pack)	Ø 16	6 mm	10	5 906554 515180
5124	Maxi 18 cm	Ø 48	6 mm	10	5 906554 513254
5125	Maxi 25 cm	Ø 48	6 mm	10	5 906554 513261











Paint roller Velur

Fabric: Velur

Intended use: Solvent-based varnishes, acrylic varnishes, oil paints

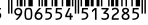



index	size	diameter	pile length		EAN
for smooth surfaces					
5167	Mini 7 cm (2-pack)	Ø 16	5 mm	10	 5 906554 511311
5181	Mini 10 cm (2-pack)	Ø 16	5 mm	10	 5 906554 515197
5182	Mini 15 cm (2-pack)	Ø 16	5 mm	10	 5 906554 515203
5172	Midi 10 cm	Ø 30	5 mm	10	 5 906554 511717
5173	Midi 15 cm	Ø 30	5 mm	10	 5 906554 511724
5126	Maxi 18 cm	Ø 48	5 mm	10	 5 906554 513278
5127	Maxi 25 cm	Ø 48	5 mm	10	 5 906554 513285



Paint roller Syntex

Fabric: polyacrylic

Intended use: emulsion and acrylic paints (including all facade paints in the facade roller variant)



index	size	diameter	pile length		EAN
for rough surfaces					
5102	Maxi 18 cm	Ø 48	18 mm	10	 5 906554 510390
5103	Maxi 25 cm	Ø 48	18 mm	10	 5 906554 510406
5104	Facade 18 cm	Ø 68	18 mm	10	 5 906554 510475
5105	Facade 25 cm	Ø 68	18 mm	10	 5 906554 510482



Paint roller Black Pasek

Fabric: polyacrylic





Intended use: latex and acrylic paints

index	size	diameter	pile length		EAN
for smooth surfaces					
5122	Maxi 18 cm	Ø 48	12 mm	10	 5 906554 512899
5123	Maxi 25 cm	Ø 48	12 mm	10	 5 906554 512905

Paint roller Moltflok

Fabric: flocked sponge

Intended use: solvent-based varnishes, acrylic varnishes, varnish stains





index	size	diameter		EAN
5155	Mini 5 cm (2-pack)	Ø 16	10	 5 906554 510222
5183	Mini 7 cm (2-pack)	Ø 16	10	 5 906554 515210
5184	Mini 10 cm (2-pack)	Ø 16	10	 5 906554 515227
5185	Mini 15 cm (2-pack)	Ø 16	10	 5 906554 515234



Paint roller Moltopren

Fabric: sponge

Intended use: acrylic varnishes, emulsion paints, stains

index	size	diameter		EAN
5151	Mini 5 cm (2-pack)	Ø 16	10	 5 906554 510185
5152	Mini 7 cm (2-pack)	Ø 16	10	 5 906554 510192
5188	Mini 10 cm (2-pack)	Ø 16	10	 5 906554 515265
5189	Mini 15 cm (2-pack)	Ø 16	10	 5 906554 515272



Paint roller for cut-offs

index	info		EAN
5241	komplet	10	 5 906554 517122



Wallpaper roller

index	size		EAN
5174	5 cm	10	 5 906554 511656
5175	15 cm	10	 5 906554 511663



Paint roller for corners

index		EAN
5179	10	 5 906554 511601





■ Painting set SOLID

Zestaw zawiera:

5762	Roller Poliamid Premium Black Silver, Maxi 25 cm, 1 pc.	55
5304	Paint roller handle Maxi \varnothing 8 25 cm, 1 pc.	48
5206	Flat paint brush 2", 1 pc.	42
5072	Translucent foil LDPE Extra Mocna 4x5 m, 1 pc.	80
5146	Masking tape Soft UV 25 mm / 50 m, 1 pc.	65
6713	Paint tray liner 25 cm, 3 pcs.	50
5310	Paint tray SOLID for roller 25 cm, 1 pc.	50

index	size		EAN
5161	25 cm	5	5 906554 510468



■ Painting set ECO

Zestaw zawiera:

5121	Paint roller Yellow Thread Maxi 25 cm, 1 pc.	56
5304	Paint roller handle Maxi \varnothing 8 25 cm, 1 pc.	48
5202	Flat paint brush 2", 1 pc.	42
5071	Masking foil HDPE Ochronna 4x5 m, 1 pc.	81
5012	Masking tape Strong 25 mm / 50 m, 1 pc.	67
5294	Paint tray ECO for roller 25 cm, 1 pc.	52

index	size		EAN
5160	25 cm	5	5 906554 510451



■ Painting set MK25

Zestaw zawiera:

5757	Roller Microfibre maxi 25 cm, 1 pc.	55
5304	Paint roller handle Maxi \varnothing 8 25 cm, 1 pc.	48
5310	Paint tray 31/35 cm, 1 pc.	50

index		EAN
5549	8	5 906554 516293



■ Painting set ZN25

Zestaw zawiera:

5121	Paint roller Yellow Thread maxi 25 cm, 1 pc.	56
5304	Paint roller handle Maxi \varnothing 8 25 cm, 1 pc.	48
5310	Paint tray 34/41 cm, 1 pc.	50

index		EAN
5548	8	5 906554 514749

Painting set MK10

Zestaw zawiera: 

5758	Paint roller Microfibre mini 10 cm, 2 pcs.	55
5301	Paint roller handle mini, 1 pc.	48
5308	Paint tray 14/30 cm, 1 pc.	61

index		EAN
5547	30	 5 906554 514732



Painting set ZN10

Zestaw zawiera: 

5194	Paint roller Yellow Thread Mini 10 cm, 2 pcs.	56
5301	Paint roller handle mini, 1 pc.	48
5308	Paint tray 14/30 cm, 1 pc.	61

index		EAN
5546	30	 5 906554 514725



Painting set Velur

Zestaw zawiera: 

5181	Paint roller Velur mini 10 cm, 2 pcs.	57
5205	Flat paint brush 1,5", 1 pc.	42
5301	Paint roller handle 10 cm, 1 pc.,	48
5308	Paint tray 16/31 cm, 1 pc.	62

index		EAN
5544	6	 5 903076 913036



Painting set MP10

Zestaw zawiera: 

5188	Paint roller Moltopren mini 10 cm, 2 pcs.	58
5301	Paint roller handle mini, 1 pc.	48
5308	Paint tray 16/31 cm, 1 pc.	50

index		EAN
5177	6	 5 906554 515029





■ Painting set MP5

Zestaw zawiera:

5151	Paint roller Moltopren mini 5 cm, 2 pcs.	58
5300	Paint roller handle mini, 1 pc.	48
5307	Paint tray 12/19 cm, 1 pc.	50

index		📦	EAN
5176		50	5 906554 515012

CLICK



■ Paint roller Black Silver + handle CLICK

Dedicated to ceramic paints

index	size	diameter	pile length	📦	EAN
for smooth surfaces					
6613	18 cm set	Ø 48	10 mm	10	5 903076 905888
6614	25 cm set	Ø 48	10 mm	10	5 903076 905895

■ Paint roller ZN10 + handle

Zestaw zawiera:

5194	Paint roller Yellow Thread Mini 10 cm, 2 pcs.	56
5301	Paint roller handle mini, 1 pc.	48



index		📦	EAN
5148		50	5 906554 518068

PLASTERING TAPE PROFESSIONAL SERIES

INNOVATIVE
GLUE FORMULA



Easy
tearing



Resistant
to atmospheric
conditions



Does not leave
any glue residue



High adhesion
to all surfaces

PROFESSIONAL SERIES

Plastering tape Professional Series

Perfect for plastering and construction work

index	size	☐	EAN
5709	10 mm / 50 m	120	5 906554 511113
5713	25 mm / 50 m	48	5 903076 908889
5712	38 mm / 50 m	32	5 906554 519676
5710	48 mm / 50 m	24	5 906554 517832



PROFESSIONAL SERIES



INNOVATIVE
GLUE
FORMULA



Plastering tape

Perfect for plastering and construction work

index	size	☐	EAN
5619	38 mm / 33 m	30	5 906554 517849
5090	48 mm / 33 m	36	5 906554 510123
5674	38 mm / 50 yd (46m)	32	5 902891 286707
5675	48 mm / 50 yd (46m)	24	5 902891 286714



SOLID STANDARD





Plastering tape

Perfect for plastering and construction work

index	size		EAN
5892	48 mm / 50 m	24	 5 903076 901255



EASY TEARING



Protective tape SPEC

Waterproof security tape for exterior and interior use

index	size		EAN
5853	38 mm / 50 m	32	 5 903076 903051
5839	48 mm / 50 m	24	 5 906554 516330



PVC tape

Waterproof securing tape

index	size		EAN
5676	38 mm / 50 m	32	 5 903076 903068
5628	48 mm / 50 m	24	 5 906554 519393



BEST PRICE



Plastering tape

- For cut-outs on plastered surfaces
- For rough surfaces

index	size		EAN
9125	38 mm / 50 yd (46m)	28	 5 903076 908926
9126	48 mm / 50 yd (46m)	24	 5 903076 908933

THOUGHTFUL

SOLUTIONS

**MASKING TAPE
SOFT UV**

**MASKING TAPE
STRONG UV**

DELICATE ADHESIVE

STRONG ADHESIVE

BEST FOR

For quick use,
right after the first coat
of paint

BEST FOR

For securing
windows and doors



Masking tape SOFT UV

index	size	📦	EAN
5146	25 mm / 50 m	36	5 906554 519492
5067	30 mm / 50 m	40	5 906554 512035
5068	38 mm / 50 m	24	5 906554 513605
5069	48 mm / 50 m	24	5 906554 513612



DELICATE ADHESIVE



Taśma malarska STRONG UV

index	size	📦	EAN
5831	25 mm / 50 m	24	5 906554 515470
5832	30 mm / 50 m	24	5 906554 515487
5833	38 mm / 50 m	24	5 906554 515494
5834	48 mm / 50 m	24	5 906554 515500



STRONG ADHESIVE



Nr 1 JAPAN
TECHNOLOGY

WASHI TAPE



Masking tape Washi SAMURAJ

No leaks, clean and sharp edges; high adhesion; waterproof

index	size	☰	EAN
5840	12 mm / 50 m	40	5 903076 900562
5819	19 mm / 50 m	32	5 903076 906410
5835	25 mm / 50 m	36	5 906554 516286
5836	30 mm / 50 m	32	5 906554 515418
5837	38 mm / 50 m	24	5 906554 515425
5838	48 mm / 50 m	24	5 906554 515432



WASHI TAPE



Masking tape Washi Delicate

Delicate LOW TACK glue, no leaks, clean and sharp edges, for delicate and smooth surfaces

index	size	☰	EAN
5550	25 mm / 50 m	36	5 906554 519188
5551	35 mm / 50 m	32	5 906554 519195
5552	45 mm / 50 m	24	5 906554 519201



WASHI TAPE



Masking tape Washi Varnish

High adhesion, thermal resistance up to 100°C; ideal for painting work

index	size	☰	EAN
5980	30 mm / 50 m	32	5 903076 913777
5981	38 mm / 50 m	24	5 903076 913784
5982	48 mm / 50 m	24	5 903076 913791



Masking tape 7 DAYS

For securing and cutting off paint; for painting and varnishing work

index	size		EAN
5843	19 mm / 50 m	48	5 903076 909657
5844	25 mm / 50 m	24	5 903076 909664
5845	30 mm / 50 m	24	5 903076 909671
5846	38 mm / 50 m	24	5 903076 909688
5847	48 mm / 50 m	24	5 903076 909695



Masking tape Economy blue

- For indoor use
- UV-resistant for up to 14 days

index	size		EAN
5849	30 mm / 50 yd (46m)	40	5 906554 519577
5850	38 mm / 50 yd (46m)	24	5 906554 519584
5851	48 mm / 50 yd (46m)	24	5 906554 519591



Masking tape Economy yellow

- For indoor use
- UV-resistant for up to 14 days

index	size		EAN
5011	19 mm / 50 m	48	5 906554 511465
5012	25 mm / 50 m	36	5 906554 511472
5013	30 mm / 50 m	40	5 906554 511489
5014	38 mm / 50 m	24	5 906554 511496
5015	48 mm / 50 m	24	5 906554 511502





■ **Pre-taped masking film STRONG UV**

Adhesive tape and foil in one; ensures quick and precise surface masking; foil thickness 10 my

index	size		EAN
5730	55 cm / 20 m	60	5 902891 286523
5731	140 cm / 20 m	30	5 902891 286530
5733	210 cm / 20 m	25	5 906554 516910
5732	270 cm / 15 m	30	5 902891 286547



■ **Pre-taped masking film 30 mm**

Foil with fabric tape, high adhesion to all surfaces, waterproof

index	size		EAN
5738	55 mm / 15 m	24	5 903076 906366
5739	140 mm / 15 m	24	5 906554 519003
5740	210 mm / 15 m	24	5 906554 512745



WASHI TAPE



■ **Pre-taped masking film Washi Green**

No leaks, clean and sharp edges; high adhesion; waterproof

index	size		EAN
5595	55 mm / 20 m	40	5 903076 913739
5596	140 mm / 20 m	30	5 903076 913746
5597	210 mm / 20 m	25	5 903076 913753
5598	270 mm / 15 m	25	5 903076 913760



■ Pre-taped masking film WASHI

No leaks, clean and sharp edges; high adhesion; waterproof

Nr 1 JAPAN
TECHNOLOGY

**WASHI
TAPE**



index	size	☐	EAN
5734	55 cm / 20 m	40	5 906554 517856
5735	140 cm / 20 m	30	5 906554 517863
5736	210 cm / 20 m	25	5 906554 517870
5737	270 cm / 15 m	25	5 903076 905116



■ Pre-taped masking film with dispenser

index	size	☐	EAN
5728	55 cm / 20 m	30	5 903076 901675
5729	270 cm / 15 m	25	5 906554 516903



■ Sliding tape

index	size	☐	EAN
9128	48 mm / 50 m	36	5 903076 900852



DOUBLE SIDED TAPE MAXI STRONG



Easy tearing

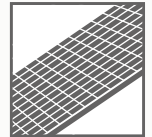

Reinforced with fabric



Ultra strong adhesive



High adhesion to all surfaces

PROFESSIONAL SERIES



Double sided reinforced tape MAXI STRONG Professional Series

Perfect for carpets, construction and gardening foils, profiles, and roofing work

index	size		EAN
5100	48 mm / 25 m	36	5 906554 514558



SOLID STANDARD



Double sided reinforced tape



Perfect for carpets, construction and garden foils, profiles and roofing work

index	size		EAN
5053	48 mm / 10 m	36	5 906554 511267
5054	48 mm / 25 m	36	5 906554 511274



■ Double sided tape Economy

- for joining foils and gluing carpets
- suitable for smooth surfaces

index	size		EAN
5056	48 mm / 10 m	36	 5 906554 510635
5057	48 mm / 25 m	36	 5 906554 510321



■ Foam tape

For quick installation of hangers and strips in household and automotive applications

index	size		EAN
5042	19 mm / 5 m	96	 5 906554 510659
5043	25 mm / 5 m	72	 5 906554 510642



■ Protective tape

For gluing roofing, garden, and construction foils;
high adhesion; waterproof

index	size		EAN
5040	48 mm / 50 m	24	 5 906554 511137



■ Aluminium tape

For use in heating and air conditioning systems

index	size		EAN
5101	48 mm / 50 yd (46 m)	24	 5 906554 511120



UNIVERSAL SUPER DUCT TAPE



Strong, reliable glue



Easy tearing



High adhesion to all surfaces



Resistant to atmospheric conditions



PROFESSIONAL SERIES

PROFESSIONAL SERIES



Universal duct tape Professional Series

High adhesion to steel, plastics, and stone; for plumbing, repair, and light construction work

index	size		EAN
5093	48 mm / 50 yd (46 m)	24	5 906554 513544



SOLID STANDARD



Universal duct tape





High adhesion to steel, plastics, and stone; for plumbing, repair, and light construction work

index	size		EAN
5024	48 mm / 25 yd (23 m)	36	5 906554 511533
5025	48 mm / 50 yd (46 m)	24	5 906554 511540



■ Fiberglass tape









For plasterboard joints; protects against cracks

index	size		EAN
5036	50 mm / 25 m	120	 5 906554 511144
5556	100 mm / 25 m	50	 5 903076 905925
5557	150 mm / 25 m	50	 5 906554 519553
5085	1000 mm / 25 m	4	 5 906554 512868



■ Fiberglass mesh tape

For plasterboard joints; protects against cracks

index	size		EAN
5060	45 mm / 20 m	84	 5 906554 512554
5061	45 mm / 45 m	56	 5 906554 512561
5062	45 mm / 90 m	42	 5 906554 512578
5063	45 mm / 150 m	24	 5 906554 512585
5031	100 mm / 20 m	24	 5 906554 510666
5032	150 mm / 20 m	25	 5 906554 510604
5720	200 mm / 20 m	12	 5 906554 517580



■ Paper tape

For plasterboard joints; protects against cracks

index	size		EAN
5708	50 mm / 75 m	24	 5 906554 516170



■ Tape with aluminium insert

For leveling and reinforcing corners, fixing their surface and preventing damage

index	size		EAN
5039	50 mm / 30 m	10	 5 906554 512820

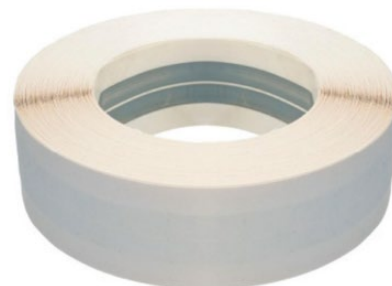

Acoustic tape

Improves the acoustic insulation of plasterboard structures; prevents vibrations from being transferred to the wall surface

index	size		EAN
5066	30 mm / 30 m	30	5 906554 513599
5033	48 mm / 30 m	10	5 906554 511984
5034	75 mm / 30 m	12	5 906554 511991
5035	95 mm / 30 m	10	5 906554 512004

Silicone tape

Waterproof, mold-resistant

index	size		EAN
5044	22 mm / 3,35 m	40	5 906554 510352
5045	38 mm / 3,35 m	20	5 906554 510369

Insulation tape

Designed for electrical work

index	size	color		EAN
5046	15 mm / 10 m	black	100	5 906554 515609
5047	15 mm / 10 m	multicolor	100	5 906554 515616
5048	19 mm / 10 m	black	96	5 906554 515623
5049	19 mm / 10 m	multicolor	96	5 906554 515630



Packing tape

For sealing cartons

index	size	color		EAN
5711	48 mm / 66 m	transparentny	36	5 906554 517382
5099	48 mm / 66 m	brązowy	36	5 906554 516163

■ Packing tape



For securing heavy parcels and sealing cartons

index	size	color		EAN
5037	50 mm / 35 m	brown	36	 5 906554 510338
5038	50 mm / 35 m	transparent	36	 5 906554 510345



■ Warning tape

Durable warning tape for securing construction sites etc.

index	size		EAN
5051	80 mm / 100 m (Premium)	30	 5 906554 510178
9127	75 mm / 100 m	24	 5 903076 909817



TRASH BAGS



Trash bags Maxi Pack

index	capacity	pcs. in a roll		EAN
5880	60 l	20	20	5 906554 515296
5860	120 l	20	11	5 906554 513438
5861	160 l	10	19	5 906554 513445
5862	240 l	10	8	5 906554 513452

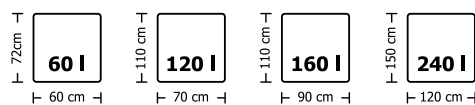

Rubble bags

index	capacity	pcs. in a roll		EAN
5082	120 l	10	9	5 906554 510130

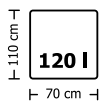

Construction bags

index	capacity	pcs. in a roll		EAN
5080	240 l	10	6	5 906554 515692

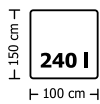

Rubble bags

index	capacity	pcs. in a roll		EAN
21141	300 l	10	6	5 903076 907301
21142	400 l	8	6	5 903076 901262

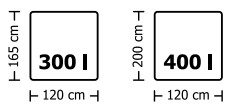

Trash bags Mega Pack LDPE

index	capacity	pcs. in a roll		EAN
5919	60 l	20	10	5 903076 901385
5920	120 l	20	11	5 903076 901392
5921	160 l	10	19	5 903076 901408
5922	240 l	10	8	5 903076 901415
5923	300 l	10	6	5 903076 901422
5924	400 l	8	6	5 903076 901439

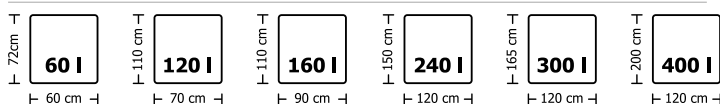



Trash bags for recycling

index	capacity	pcs. in a roll	color		EAN
5886	120 l	10	yellow	10	5 906554 515302
5887	120 l	10	blue	10	5 906554 515319
5888	120 l	10	green	10	5 906554 517696
5889	120 l	10	brown	10	5 906554 517702
5878	160 l	10	brown	14	5 903076 911865
5876	160 l	10	yellow	14	5 903076 911841
5879	240 l	10	brown	8	5 903076 911872
5877	240 l	10	yellow	8	5 903076 911858

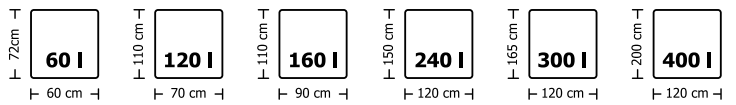

Trash bags Silver Pack LDPE with tape

index	capacity	pcs. in a roll		EAN
5864	60 l	15	10	5 906554 513476

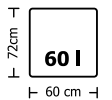

Trash bags Super Pack LDPE



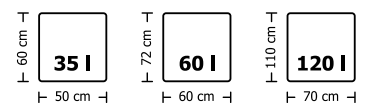

index	capacity	pcs. in a roll		EAN
5077	35 l	30	10	5 906554 515661
5078	60 l	20	10	5 906554 515678
5079	120 l	10	10	5 906554 515708



PROTECTIVE FILMS



■ Transparent foil LDPE

index	type	dimensions	weight		EAN	packaging
5095	SOFT	20 m ² (4 × 5 m)	450 g	35	5 906554 513568	
5094	HARD	20 m ² (4 × 5 m)	700 g	22	5 906554 513551	
5961	MEGA	20 m ² (4 × 5 m)	1000 g	12	5 906554 519799	
5962	MAXI	20 m ² (4 × 5 m)	1500 g	10	5 906554 519805	



■ Transparent foil LDPE



index	dimensions		EAN
5555	4 × 5 m = 20 m ²	32	5 903076 907318



■ Translucent foil SŁOMKA LDPE



index	type	dimensions	weight		EAN	packaging
5072	EXTRA MOCNA	20 m ² (4 × 5 m)	250 g	45	5 902891 286011	
5073	STRONG	20 m ² (4 × 5 m)	450 g	25	5 906554 511397	
5074	SUPER GRUBA	20 m ² (4 × 5 m)	700 g	20	5 902891 286035	
5075	BUDOWLANA	20 m ² (4 × 5 m)	1000 g	12	5 902891 286202	
5958	PLANDEKA	20 m ² (4 × 5 m)	1500 g	10	5 906554 519768	



Black foil LDPE



index	type	dimensions	weight		EAN	packaging
5086	EXTRA ECO	20 m ² (4 × 5 m)	250 g	35	5 906554 517337	
5097	STRONG ECO	20 m ² (4 × 5 m)	450 g	30	5 906554 513643	
5098	SUPER ECO	20 m ² (4 × 5 m)	700 g	22	5 906554 513650	
5956	MEGA ECO	20 m ² (4 × 5 m)	1000 g	12	5 906554 519744	
5870	MAXI ECO	20 m ² (4 × 5 m)	1500 g	10	5 906554 517528	



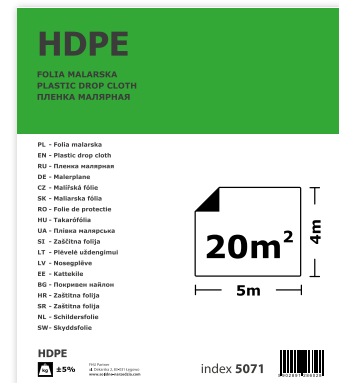

Masking foil HDPE

index	dimensions	wieght		EAN
5071	4 × 5 m = 20 m ²	60 g	40	5 902891 286028

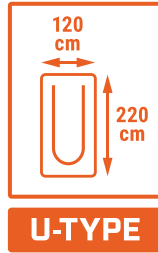



■ Zipper door

index	dimensions	type		EAN
6279	120 × 220 cm	with double-sided tape 25 mm / 7 m	10	 5 903076 905932
6280	120 × 220 cm	none	10	 5 906554 519966



■ Temporary foil gutter

index	diameter	length		EAN
6200	Ø 75 – 125 mm	20 m	15	 5 903076 907509



■ Plastic foil in roll TRANSPARENT

index	dimensions		EAN
5872	2 m / 50 m	1	 5 906554 517542



■ Plastic foil in roll TRANSLUCENT

index	dimensions		EAN
5871	2 m / 50 m	1	 5 906554 517535

■ Protection film blue

index	dimensions		EAN
9989	300 mm / 50 m	6	5 903076 913326
9990	500 mm / 30 m	6	5 906554 519409
9991	500 mm / 50 m	6	5 903076 908964
9992	500 mm / 75 m	6	5 903076 901651
9993	500 mm / 100 m	6	5 903076 901668



■ Self-adhesive transparent window protection film

index	dimensions		EAN
5891	500 mm / 50 m	6	5 906554 512370
5890	500 mm / 75 m	6	5 903076 913319



■ Stretch film

index	dimensions	color		EAN
5091	500 mm / 1,3 kg	transparent	6	5 906554 515677
5076	500 mm / 2,3 kg	transparent	6	5 906554 512011
5092	500 mm / 1,3 kg	black	6	5 906554 515654



■ Fleece dust sheet

Lined with waterproof foil

index	size	weight		EAN
5894	1 m × 10 m	220 g/m ²	6	5 903076 904874
5895	1 m × 25 m	220 g/m ²	6	5 903076 907257

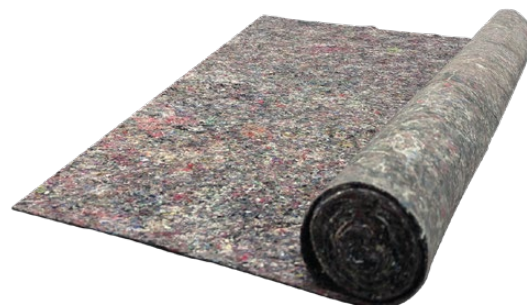















■ Polypropylene bag

index	dimensions		EAN
5580	60 cm × 105 cm	100	 5 906554 518693











■ Plastic foil sleeve in roll

index	size		EAN
6199	100 cm × 20 lm	6	 5 903076 913418

■ Tarpauline blue







index	size	weight		EAN
5857	2 m × 3 m	60 g/m ²	40	 5 906554 518655
5858	3 m × 4 m	60 g/m ²	20	 5 906554 518662
5859	4 m × 5 m	60 g/m ²	12	 5 906554 518679
5963	4 m × 6 m	60 g/m ²	10	 5 903076 911063
5965	5 m × 6 m	60 g/m ²	10	 5 903076 911087
5964	4 m × 8 m	60 g/m ²	10	 5 903076 911070
5854	5 m × 8 m	60 g/m ²	6	 5 906554 518792
5966	6 m × 8 m	60 g/m ²	6	 5 903076 911094
5855	6 m × 10 m	60 g/m ²	5	 5 906554 518808
5967	8 m × 10 m	60 g/m ²	4	 5 903076 911100
5856	8 m × 12 m	60 g/m ²	3	 5 906554 518815
5968	10 m × 12 m	60 g/m ²	2	 5 903076 911117
5969	10 m × 15 m	60 g/m ²	2	 5 903076 911124

■ **Tarpauline green**

index	size	weight		EAN
5931	2 m × 3 m	90 g/m ²	25	 5 903076 905055
5932	3 m × 4 m	90 g/m ²	10	 5 903076 905062
5933	4 m × 5 m	90 g/m ²	10	 5 903076 905079
5970	4 m × 6 m	90 g/m ²	8	 5 903076 911131
5972	5 m × 6 m	90 g/m ²	6	 5 903076 911155
5971	4 m × 8 m	90 g/m ²	6	 5 903076 911148
5934	5 m × 8 m	90 g/m ²	5	 5 903076 905086
5973	6 m × 8 m	90 g/m ²	3	 5 903076 911162
5935	6 m × 10 m	90 g/m ²	4	 5 903076 905093
5974	8 m × 10 m	90 g/m ²	2	 5 903076 911179
5936	8 m × 12 m	90 g/m ²	2	 5 903076 905109
5975	10 m × 12 m	90 g/m ²	2	 5 903076 911186
5976	10 m × 15 m	90 g/m ²	1	 5 903076 911193



■ **Tarpauline silver**

index	size	weight		EAN
5937	2 m × 3 m	120 g/m ²	20	 5 903076 905307
5938	3 m × 4 m	120 g/m ²	10	 5 903076 905314
5939	4 m × 5 m	120 g/m ²	5	 5 903076 905321
5941	5 m × 8 m	120 g/m ²	3	 5 903076 905338
5942	6 m × 10 m	120 g/m ²	2	 5 903076 905345
5943	8 m × 12 m	120 g/m ²	1	 5 903076 905352



SKIMMING SPATULA PROFESSIONAL SERIES



CHOOSE ACCESSORIES:



Anodized
aluminum



Skimming blade
adaptor
index 6401
p. 87



Telescopic
handle
index 6400
p. 87



Aluminium
pole
index 6402
p. 87



PROFESSIONAL SERIES

Skimming spatula Professional Series

Acid-resistant stainless steel, thickness: 0.3 mm;
high-rigidity aluminum profile

index	size		EAN
6409	250 mm	1	5 903076 900913
6410	350 mm	1	5 903076 900920
6411	450 mm	1	5 903076 900937
6412	550 mm	1	5 903076 900944
6413	650 mm	1	5 903076 900951
6414	800 mm	1	5 903076 900968
6415	1000 mm	1	5 903076 900975



■ Skimming blade adaptor

index			EAN
6401		10	 5 903076 900180



■ Telescopic handle

30% lighter than a standard stick, foldable

index	size		EAN
6400	1,0 – 1,8 m	25	 5 903076 900142









■ Aluminium pole

index	size		EAN
6402	1,6 m	10	 5 903076 900197



■ Plaster roller

index	size		EAN
6219	80 mm	5	 5 903076 906373
6220	180 mm	10	 5 903076 908131
6222	220 mm	5	 5 903076 906380
6221	250 mm	10	 5 903076 907349
6224	350 mm	5	 5 906554 518891
6226	460 mm	5	 5 906554 518914



■ Plaster roller + handle with CLICK



index	size		EAN
6201	80 mm	20	 5 903076 907615
6202	220 mm	20	 5 903076 907622

■ Corner smoothing roller



index	size		EAN
6209	80 mm	5	 5 903076 906397

■ Smoothing roller + handle with CLICK



index	size		EAN
6203	80 mm	20	 5 903076 907424

■ Plaster tools set Professional Series

PROFESSIONAL SERIES

index		EAN
6419	1	 5 903076 901057

Zestaw zawiera: 

6400	Telescopic handle	87
6401	Skimming blade adaptor	87
6410	Skimming spatula Professional Series 350 mm	86
6412	Skimming spatula Professional Series 550 mm	86
6414	Skimming spatula Professional Series 800 mm	86
6541	Replaceable blade for skimming spatula Light 550 mm	90
6539	Skimming blade adaptor Light	91
6221	Plaster roller 250 mm	87
5304	Roller handle MAXI Ø8 25 cm	48
6403	Case 120 cm	89



■ Case 120 cm

index		EAN
6403	1	 5 903076 900609



SKIMMING SPATULA SUPER LIGHT



SUPER LIGHT

CHOOSE ACCESSORIES:

40% lighter
than a standard
plastering knife

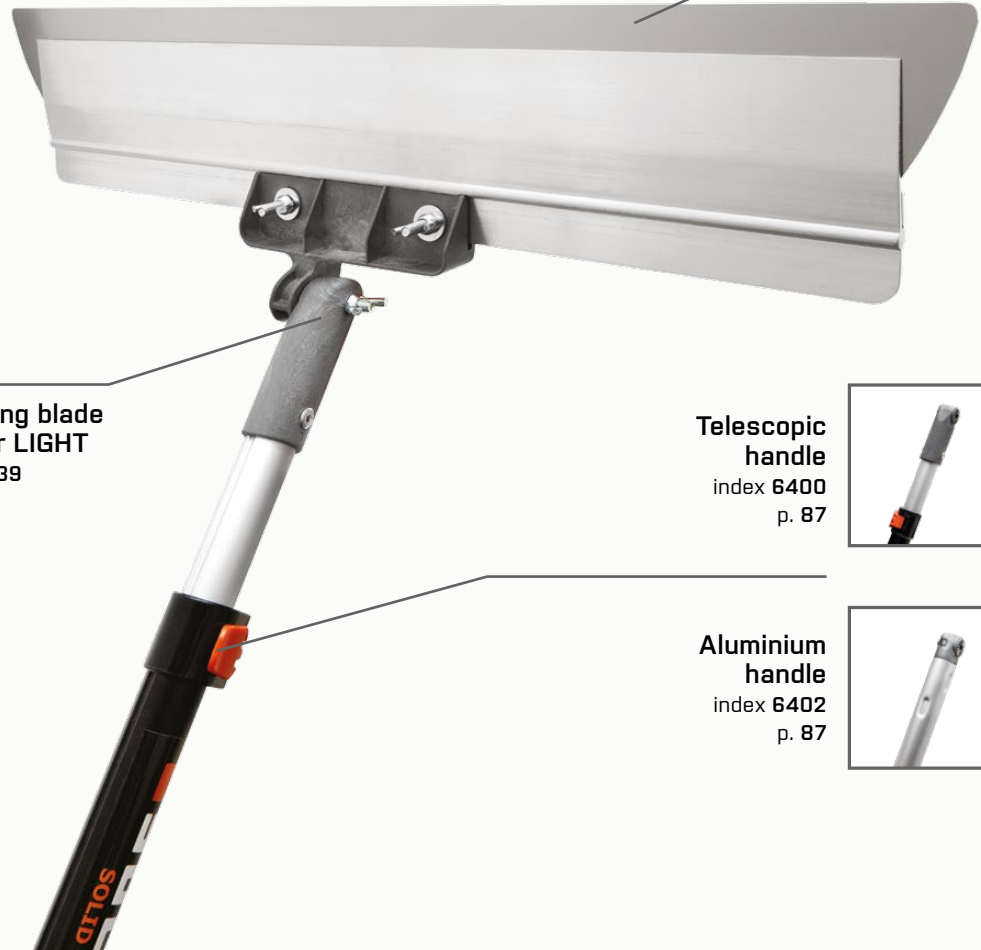

**Skimming blade
adaptor LIGHT**
index 6539
p. 91

**Telescopic
handle**
index 6400
p. 87



**Aluminium
handle**
index 6402
p. 87



Replaceable blade for skimming spatula Light

Acid-resistant stainless steel, thickness: 0.3 mm;
high-rigidity aluminum profile



index	size		EAN
6540	350 mm	10	5 903076 901002
6541	550 mm	10	5 903076 901019
6542	800 mm	10	5 903076 901026

■ Skimming spatula Light - set

index		EAN
6538	3	 5 903076 900982

Zestaw zawiera: 

6400	Telescopic handle	87
6539	Skimming blade adaptor LIGHT	91
6541	Replaceable blade for skimming spatula Light 550 mm	90
6542	Replaceable blade for skimming spatula Light 800 mm	90

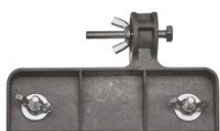

■ Skimming blade adaptor LIGHT

index		EAN
6539	10	 5 903076 900999

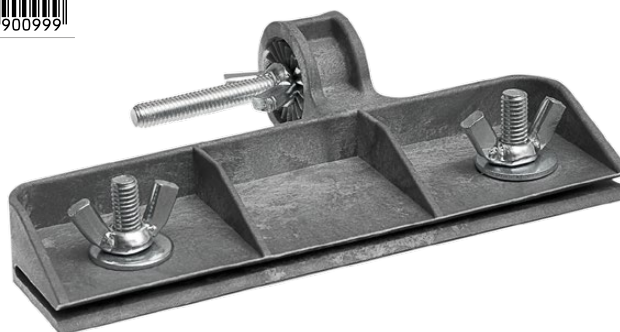

TAPING KNIFE PROFESSIONAL SERIES



 **0,3 mm**



Rounded, polished corners



Bracket for finishing spatula
index 6355
p. 94

Telescopic handle
index 6400
p. 87





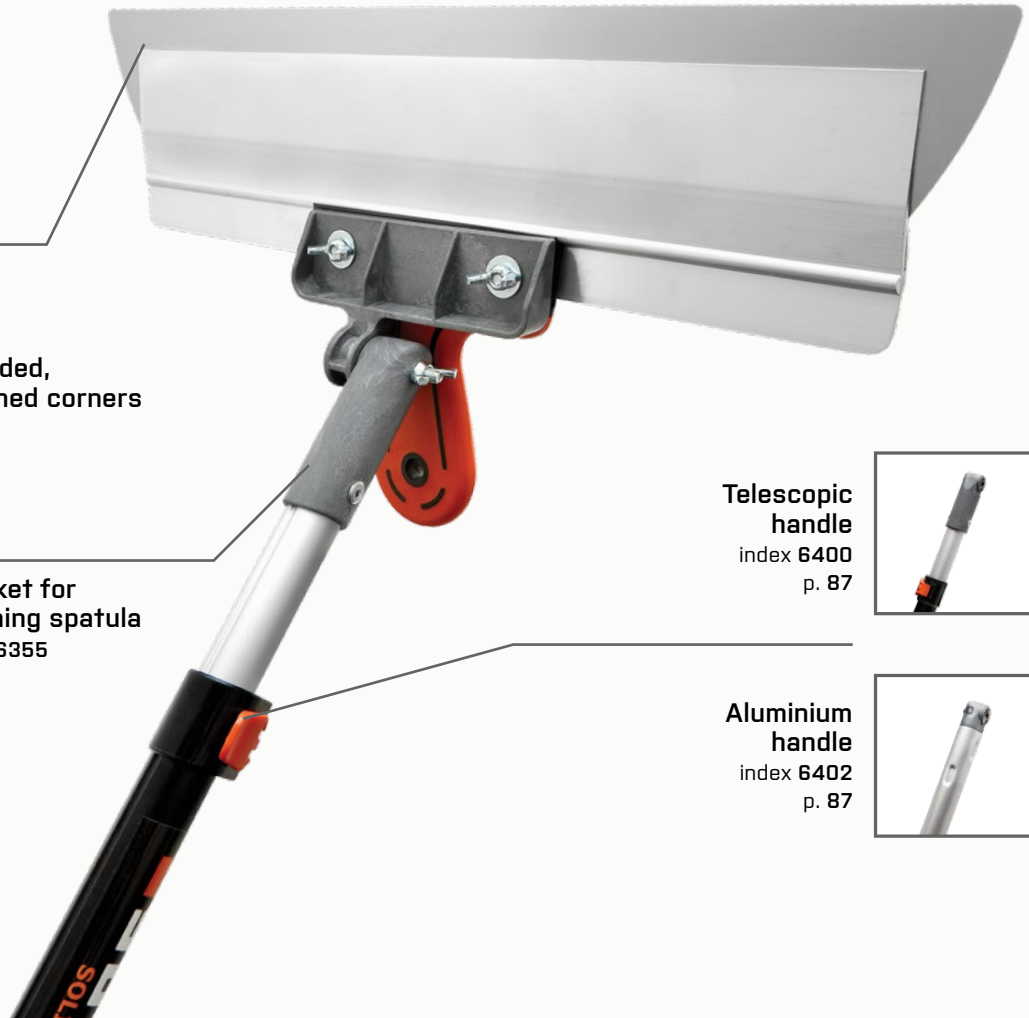



Aluminium handle
index 6402
p. 87



Stainless steel taping knife Professional Series

Acid-resistant stainless steel, thickness: 0.3 mm;
high-rigidity aluminum profile



index	size		EAN
6350	250 mm	5	 5 903076 908742
6351	350 mm	5	 5 903076 908759
6352	450 mm	5	 5 903076 908766
6353	550 mm	5	 5 903076 908773
6354	650 mm	5	 5 903076 908780

■ **Stainless steel taping knife h. 2C**

Acid-resistant stainless steel, thickness: 0.4 mm;
high-rigidity aluminum profile



index	size	☐	EAN
6099	150 mm	5	5 906554 516231
6100	250 mm	5	5 906554 516248
6101	350 mm	5	5 906554 516255
6098	450 mm	5	5 906554 511045
6102	550 mm	5	5 906554 516262
6103	650 mm	5	5 906554 516279



Rounded,
polished
corners

**CHOOSE
THE RIGHT
ACCESSORIES**



**Telescopic
handle**

index **6400** p. 87



**Aluminium
pole**

index **6402** p. 87



**Bracket for
finishing spatula**

index **6355** p. 94

■ **Stainless steel finishing spatula h. 2C**

Acid-resistant stainless steel, thickness: 0.5 mm;
high-rigidity aluminum profile



index	size	☐	EAN
6077	150 mm	5	5 906554 514060
6082	250 mm	5	5 906554 514084
6090	350 mm	5	5 906554 514114
6091	450 mm	5	5 906554 514121
6092	550 mm	5	5 906554 514138
6096	650 mm	5	5 906554 510048



Rounded,
polished
corners

**CHOOSE
THE RIGHT
ACCESSORIES**



**Telescopic
handle**

index **6400** p. 87



**Aluminium
pole**

index **6402** p. 87



**Bracket for
finishing spatula**

index **6355** p. 94

■ **Stainless steel taping knife Professional Series h. cork**

index	size	☐	EAN
21729	250 mm	5	5 903076 907721
21730	450 mm	3	5 903076 907738
21731	650 mm	3	5 903076 913432



**CHOOSE
THE RIGHT
ACCESSORIES**



**Telescopic
handle**

index **6400** p. 87



**Aluminium
pole**

index **6402** p. 87



**Bracket for
finishing spatula**

index **6355** p. 94



0,5 mm

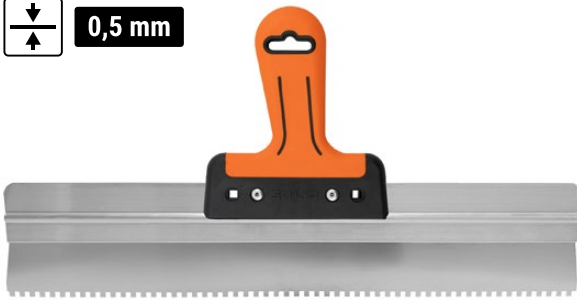

■ **Stainless steel notch finishing spatula h. 2C**

Acid-resistant stainless steel, thickness: 0.5 mm;
high-rigidity aluminum profile

index	size	ząb		EAN
6277	450 mm	4 mm	5	5 903076 909701

**CHOOSE
THE RIGHT
ACCESSORIES**



**Telescopic
handle**

index **6400** p. **87**



**Aluminium
pole**

index **6402** p. **87**



**Bracket for
finishing spatula**

index **6355** p. **94**



■ **Stainless steel stripping knife h. 2C**

Stainless steel, thickness: 0.5 mm

index	size		EAN
5646	150 mm	10	5 906554 518365
5647	200 mm	10	5 906554 518372
5648	250 mm	10	5 906554 518389
5649	300 mm	10	5 906554 518396
5660	350 mm	10	5 906554 512332
5661	450 mm	10	5 906554 512349
5662	600 mm	10	5 906554 512356

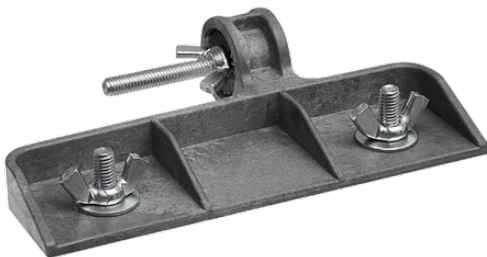

■ **Bracket for finishing spatula**

Angle adjustable handle

index		EAN
6355	5	5 903076 901064



■ **Bracket for finishing spatula**

index		EAN
5990	10	5 906554 516811

Stainless steel spatula h. wood

Stainless steel, acid-resistant, polished to obtain appropriate elasticity

index	size		EAN
6336	50 mm	12	5 903076 913159
6337	100 mm	12	5 903076 913166
6338	150 mm	12	5 903076 913173
6339	200 mm	12	5 903076 913180



Spatula TPR

Stainless steel, acid-resistant, polished to obtain appropriate elasticity

index	size		EAN
6327	25 mm	12	5 903076 913074
6328	38 mm	12	5 903076 913081
6329	50 mm	12	5 903076 913098
6330	76 mm	12	5 903076 913104
6331	100mm	12	5 903076 913111
6332	125 mm	12	5 903076 913128
6333	150 mm	12	5 903076 913135
6334	200 mm	12	5 903076 913142



Stainless steel spatula h. 2C

Stainless steel, acid-resistant, polished to obtain appropriate elasticity

index	size		EAN
6071	40 mm	12	5 906554 514008
6072	60 mm	12	5 906554 514015
6073	80 mm	12	5 906554 514022
6074	100 mm	12	5 906554 514039
6075	120 mm	12	5 906554 514046
6076	150 mm	12	5 906554 514053



Stainless steel spatula h. 2C

Stainless steel, acid-resistant, polished to obtain appropriate elasticity

index	size		EAN
6261	40 mm	12	5 903076 909947
6262	60 mm	12	5 903076 909954
6263	80 mm	12	5 903076 909961
6264	100 mm	12	5 903076 909978
6265	120 mm	12	5 903076 909985
6266	150 mm	12	5 903076 909992





■ **Stainless steel spatula MULTI h. 2C**
Stainless steel, acid-resistant

index		☐	EAN
6267		12	5 906554 519980



■ **Stainless steel spatula with bit**

index	size	☐	EAN
6278	150 mm	5	5 903076 903075



■ **Stainless steel spatula h. ABS**
Stainless steel, acid-resistant

index	size	☐	EAN
5570	40 mm	6	5 906554 518228
5571	60 mm	6	5 906554 518235
5572	80 mm	6	5 906554 518242
5573	100 mm	6	5 906554 518259
5574	120 mm	6	5 906554 518266







■ **Bucket scoop**

index	size	☐	EAN
6276	165 mm	5	5 903076 901972

■ **Stainless steel spatula**

Stainless steel, thickness: 0.5 mm

index	size		EAN
5324	40 mm	10	 5 906554 514770
5325	60 mm	10	 5 906554 514787
5326	80 mm	10	 5 906554 514794
5327	100 mm	10	 5 906554 514800



■ **Stainless steel spatula**

index	size		EAN
5323	37×120 mm	70	 5 906554 514763
5322	90×120 mm	60	 5 906554 514756



■ **Stripping knife**

index	material		EAN
6085	stainless steel	10	 5 902891 286639
6086	PVC	10	 5 902891 286646



■ **Stainless steel trapezoidal notched spatula**

Square notch

index	size	notch		EAN
5654	150 mm	4 mm	12	 5 906554 518648
5653	150 mm	6 mm	12	 5 906554 518419
5579	150 mm	B11	12	 5 903076 903082



STAINLESS STEEL TROWEL WITH ALUMINIUM FRAME



Ergonomic two-component handle

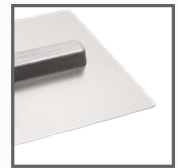

Rounded polished corners

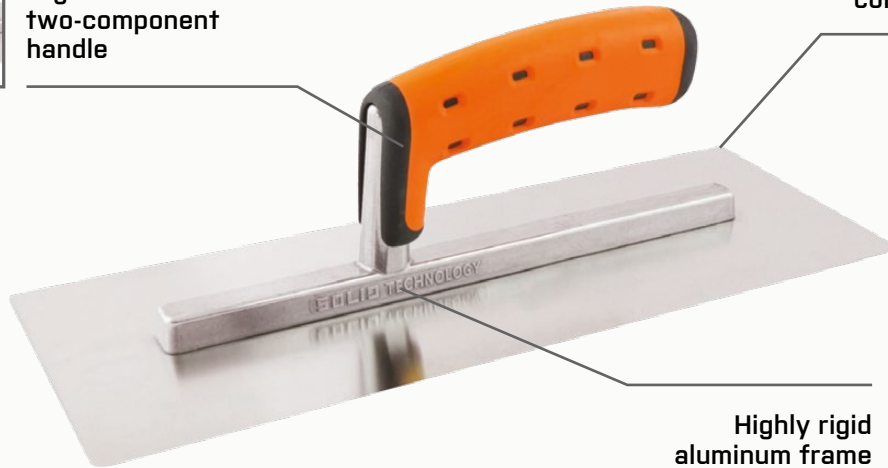

Highly rigid aluminum frame



PROFESSIONAL SERIES



Plastering trowel Professional Series h. 2C

Aluminum frame stainless steel, acid-resistant, thickness: 0.7 mm

index	size	📦	EAN
6268	120×280 mm	6	5 903076 908605
6269	120×305 mm	4	5 903076 908612
6270	120×330 mm	4	5 903076 908629
6271	120×355 mm	4	5 903076 908636
6272	120×380 mm	4	5 903076 908643
6273	120×405 mm	4	5 903076 908650
6274	120×450 mm	4	5 903076 908667



Plastering trowel Premium r. korek

Aluminum frame; stainless steel, acid-resistant, thickness: 0.7 mm

index	size	📦	EAN
21434	120×280 mm	6	5 903076 901583
21625	120×305 mm	4	5 903076 905444
21626	120×330 mm	4	5 903076 905451
21435	120×355 mm	4	5 903076 901590
21506	120×380 mm	4	5 903076 904010
21627	120×405 mm	4	5 903076 905468
21628	120×450 mm	4	5 903076 905475

Stainless steel trowel h. 2C











Aluminum frame; stainless steel, acid-resistant, thickness: 0.7 mm

index	size		EAN
6000	120×270 mm	6	 5 906554 513674



Stainless steel notch trowel h. 2C

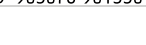

Aluminum bar; stainless steel, acid-resistant, thickness: 0.7 mm

index	size	notch		EAN
6249	130×270 mm	2 mm	6	 5 906554 519997
6258	130×270 mm	3 mm	6	 5 903076 903709
6001	130×270 mm	4 mm	6	 5 906554 513681
6002	130×270 mm	6 mm	6	 5 906554 513698
6003	130×270 mm	8 mm	6	 5 906554 513704
6004	130×270 mm	10 mm	6	 5 906554 513711
6005	130×270 mm	12 mm	6	 5 906554 512998
6259	130×270 mm	15 mm	6	 5 903076 903716
6008	130×270 mm	B11 mm	6	 5 903076 901330



Stainless steel notch trowel h. 2K

Aluminum frame; stainless steel, acid-resistant, thickness: 0.7 mm

index	size	notch		EAN
6237	130×270 mm	semicircular	6	 5 906554 519096



Stainless steel plastering trowel h. 2C

Aluminum frame; stainless steel, acid-resistant, thickness: 0.7 mm

index	size		EAN
6020	130×270 mm	6	 5 906554 518785





■ **Stainless steel venetian trowel h. cork**

Hardened stainless steel, thickness: 0.5 mm

index	size	📦	EAN
21505	200 mm	10	5 903076 904003
21504	240 mm	10	5 903076 903990



■ **Stainless steel venetian trowel h. 2C**

Hardened stainless steel, thickness: 0.65 mm

index	size	📦	EAN
6034	80×200 mm	10	5 906554 513858
6035	90/110×240 mm	10	5 906554 513865



■ **Stainless steel curved drywall trowel h. 2C**

Aluminum frame; stainless steel, acid-resistant, thickness: 0.7 mm

index	size	📦	EAN
6275	120×300 mm	4	5 903076 908674



■ **Stainless steel plastering trowel h. 2C**

Aluminum frame; stainless steel, acid-resistant, thickness: 0.7 mm

index	size	📦	EAN
6257	130×300 mm	6	5 903076 900586

Pointed concrete trowel h. 2C

Aluminum frame; carbon steel, thickness: 1.2 mm

index	size		EAN
6030	500 mm	2	 5 906554 513810
6031	600 mm	2	 5 906554 513827



Stainless steel plastering trowel h. wood

Aluminum frame; stainless steel, acid-resistant, thickness: 0.7 mm

index	size		EAN
6006	130x270 mm	6	 5 906554 513728



Stainless steel plastering trowel h. wood FSC 100%











Stainless steel, acid-resistant, thickness: 0.7 mm

index	size		EAN
6010	130x380 mm	4	 5 906554 513742
6011	130x480 mm	4	 5 906554 513759
6016	130x580 mm	4	 5 906554 513797
6017	130x680 mm	4	 5 906554 513803



Stainless steel notch trowel h. wood FSC 100%

Stainless steel, acid-resistant, thickness: 0.7 mm

index	size	notch		EAN
6210	130x380 mm	6 mm	4	 5 906554 518143
6211	130x380 mm	8 mm	4	 5 906554 518150
6212	130x380 mm	10 mm	4	 5 906554 518167
6213	130x380 mm	12 mm	4	 5 906554 518174
6012	130x480 mm	6 mm	4	 5 906554 513766
6013	130x480 mm	8 mm	4	 5 906554 513773
6014	130x480 mm	10 mm	4	 5 906554 513780
6019	130x480 mm	12 mm	4	 5 906554 511052
6015	130x480 mm	semicircular	4	 5 906554 515555



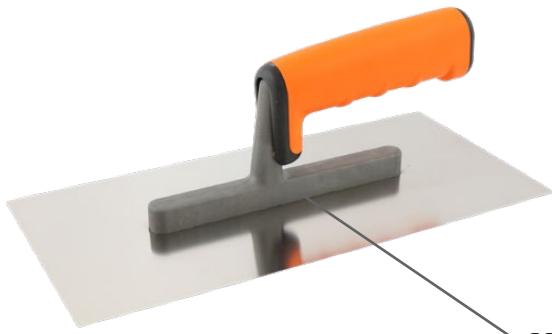

■ **Stainless steel plastering trowel h. 2C**

Composite frame; stainless steel, acid-resistant, thickness: 0.7 mm

index	size		EAN
6250	130×270 mm	6	5 906554 519416

Lightweight
composite frame



■ **Stainless steel plastering trowel h. 2C**

Composite frame; stainless steel, acid-resistant, thickness: 0.7 mm

index	size		EAN
6048	120×280 mm	6	5 902891 286141
6049	120×305 mm	4	5 902891 286158
6050	120×330 mm	4	5 902891 286165
6051	120×355 mm	4	5 902891 286172
6052	120×380 mm	4	5 902891 286189
6053	120×405 mm	4	5 902891 286196



■ **Stainless steel notch trowel h. 2C**

Composite frame; stainless steel, acid-resistant, thickness: 0.7 mm

index	size	notch		EAN
6247	130×270 mm	2 mm	6	5 903076 903747
6248	130×270 mm	3 mm	6	5 903076 903754
6251	130×270 mm	4 mm	6	5 906554 519423
6252	130×270 mm	6 mm	6	5 906554 519430
6253	130×270 mm	8 mm	6	5 906554 519447
6254	130×270 mm	10 mm	6	5 906554 519454
6255	130×270 mm	12 mm	6	5 906554 519461
6281	130×270 mm	15 mm	6	5 903076 903761
6283	130×270 mm	B11 mm	6	5 903076 903785



■ **Stainless steel notch trowel h. 2C**

Composite frame; stainless steel, acid-resistant, thickness: 0.7 mm

index	size	notch		EAN
6282	130×270 mm	semicircular	6	5 903076 903778

■ Stainless steel plastering trowel h. EURO











Stainless steel, acid-resistant, thickness: 0.7 mm

index	size		EAN
6009	130×270 mm	6	 5 906554 512103



■ Stainless steel notch trowel h. EURO



Stainless steel, acid-resistant, thickness: 0.7 mm

index	size	notch		EAN
6286	130×270 mm	2 mm	6	 5 903076 903723
6287	130×270 mm	3 mm	6	 5 903076 903730
6021	130×270 mm	4 mm	6	 5 906554 515715
6022	130×270 mm	6 mm	6	 5 906554 515722
6023	130×270 mm	8 mm	6	 5 906554 515739
6024	130×270 mm	10 mm	6	 5 906554 515746
6025	130×270 mm	12 mm	6	 5 906554 515753
6026	130×270 mm	15 mm	6	 5 906554 517658
6028	130×270 mm	B11 mm	6	 5 906554 512981



■ Stainless steel notch trowel h. EURO

Stainless steel, acid-resistant, thickness: 0.7 mm

index	size	notch		EAN
6027	130×270 mm	semicircular	6	 5 906554 512974



■ Stainless steel plastering trowel h. ERGO

Stainless steel, acid-resistant, thickness: 0.7 mm



index	size		EAN
6018	130×270 mm	6	 5 906554 515531





■ **Stainless steel notch trowel h. ERGO**

Stainless steel, acid-resistant, thickness: 0.7 mm

index	size	notch		EAN
6214	130×270 mm	4 mm	6	
6215	130×270 mm	6 mm	6	
6216	130×270 mm	8 mm	6	
6217	130×270 mm	10 mm	6	
6218	130×270 mm	12 mm	6	

■ **Stainless rasp for wool and styrofoam**

Stainless steel, acid-resistant



index	size		EAN
6260	180×330 mm	2	

Stainless steel,
high durability



■ **Rasp float**

index	size		EAN
6862	130×270 mm	20	
6859	160×380 mm	10	



0,4 mm



■ **Plastic texture trowel h. EURO**

ABS plastic, thickness: 4 mm

index	size		EAN
6039	140×280 mm	20	

■ Plastic texture trowel h. ERGO

ABS plastic, thickness: 4 mm



index	size		EAN
6239	140×280 mm	6	 5 906554 519812











■ Texture trowel h. PROFI

Thickness: 2 mm

index	size		EAN
5336	130×270 mm	6	 5 906554 513520



■ Styrofoam float

index	size	type		EAN
5370	130×270 mm	straight	10	 5 906554 511403
5371	170×320 mm	straight	10	 5 906554 511410
5354	140×400 mm	straight	10	 5 906554 512110
5372	130×600 mm	straight	10	 5 906554 511427
5373	140×700 mm	straight	10	 5 906554 511434
5374	140×1000 mm	straight	10	 5 906554 511441
5355	80×340 mm	angled	10	 5 906554 511182



■ Styrofoam float STRONG

index	size		EAN
5993	140×280 mm	8	 5 902891 286592
5994	180×320 mm	8	 5 902891 286608
5995	140×500 mm	10	 5 906554 516828



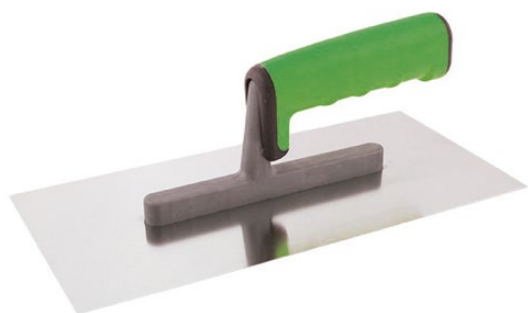

■ **Stainless steel plastering trowel h. 2C**
 Composite frame; stainless steel, thickness: 0.65 mm

index	size		EAN
5339	120×270 mm	6	 5 906554 514657



■ **Stainless steel plastering trowel h. wood**
 Composite frame; stainless steel, thickness: 0.65 mm

index	size		EAN
5428	120×270 mm	6	 5 906554 517788



■ **Stainless steel plastering trowel h. PROFI**
 Stainless steel, thickness: 0.65 mm

index	size		EAN
5321	120×270 mm	6	 5 906554 512059





■ **Stainless steel plastering trowel h. wood**
 Stainless steel, thickness: 0.65 mm

index	size		EAN
5347	120×380 mm	4	 5 906554 510147
5348	120×480 mm	4	 5 906554 510154
5349	120×580 mm	4	 5 906554 510161



■ **Stainless steel notch trowel h. PROFI**
 Stal nierdzewna, thickness: 0,65 mm

index	size	notch		EAN
5341	120×270 mm	4 mm	6	 5 906554 513339
5342	120×270 mm	6 mm	6	 5 906554 513346
5343	120×270 mm	8 mm	6	 5 906554 513353
5344	120×270 mm	10 mm	6	 5 906554 513360
5345	120×270 mm	12 mm	6	 5 906554 513377

SWIVEL FLOAT LIGHT

30% LIGHTER

THAN STANDARD SWIVEL FLOAT

Durable handle made of technical plastic. Quick assembly with a lightweight aluminum pole



Telescopic handle
index **6400**
p. 87



Aluminium pole
index **6402**
p. 87



■ Swivel float with rubber sponge Light

index	size	thickness		EAN
6405	200×400 mm	18 mm	2	 5 903076 900548

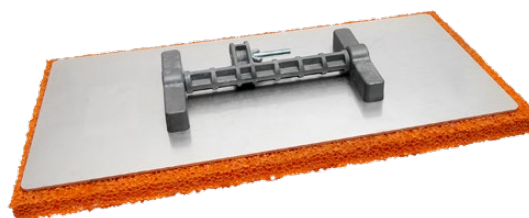

CHOOSE THE RIGHT ACCESSORIES



Telescopic handle
p. 87

or



Aluminium pole
p. 87

SWIVEL FLOAT STANDARD





Classic
steel mounting

Wooden handle
for swivel float
index 5784
p. 108



Swivel float with rubber sponge STRONG



index	size	thickness		EAN
6054	200x400 mm	18 mm	2	 5 906554 517511

Wooden handle for the swivel float

index	size		EAN
5784	180 cm	10	 5 906554 517368



■ Float with orange rubber sponge

index	size	thickness		EAN
6040	130×250 mm	18 mm	12	 5 906554 513896
6620	140×280 mm	18 mm	12	 5 903076 901071





■ Float with yellow rubber sponge

index	size	thickness		EAN
5360	130×250 mm	18 mm	12	 5 906554 516866





■ Float with blue rubber sponge

index	size	thickness		EAN
6240	130×250 mm	18 mm	12	 5 906554 519378





■ Replacement pads for floats

index	size	thickness		EAN
6070	200×400 mm	18 mm	10	 5 906554 514978



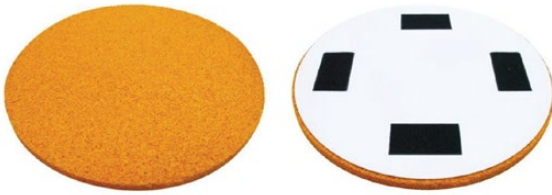



■ Rubber sponge smoothing disc



index	size	sponge		EAN
6373	∅ 400 mm	orange 18 mm	10	 5 903076 908711



■ Sponge plaster smoothing disc

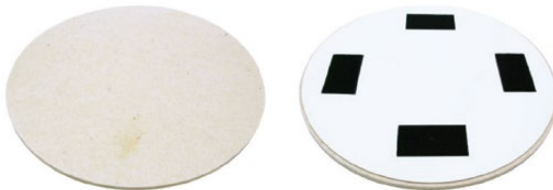

index	size	sponge		EAN
6370	∅ 400 mm	gray 50 mm	5	 5 903076 908681
6371	∅ 400 mm	hydro-absorbent yellow 50 mm	5	 5 903076 908698
6372	∅ 400 mm	hydro-absorbent brown 50 mm	5	 5 903076 908704

■ Felt smoothing disc



index	size	thickness		EAN
6204	∅ 360 mm	8 mm	10	 5 906554 518754
6205	∅ 400 mm	8 mm	10	 5 903076 908728

■ Flooring scraper
Hardened steel blade



index	size		EAN
6181	300 mm	4	 5 906554 514541

Wooden handle for scraper

index	size		EAN
5786	150 mm	10	 5 906554 519607

■ Aluminum wall plane

index	size		EAN
6180	90×450 mm	5	 5 906554 514534



■ Steel wall plane

index	size		EAN
6179	140×280 mm	6	 5 906554 510062



■ Rasp float ECO

index	size		EAN
5398	130×250 mm	10	 5 903076 900043





■ Float with felt

index	size	thickness		EAN
6044	130×250 mm	8 mm	20	 5 906554 513933







■ Float with yellow hydro-absorbent sponge

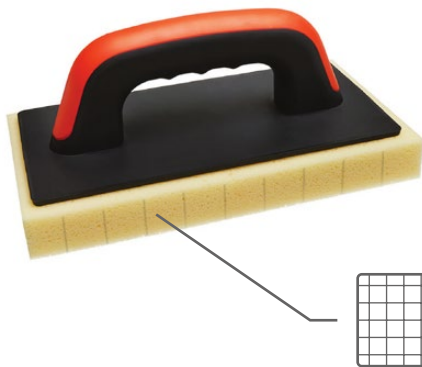

index	size	thickness		EAN
6045	130×250 mm	30 mm	12	 5 906554 513940
6621	140×280 mm	30 mm	12	 5 903076 901088



■ Float with yellow, notched, hydro-absorbent sponge



index	size	thickness		EAN
6106	130×250 mm	30 mm	12	 5 906554 518952
6622	140×280 mm	30 mm	12	 5 903076 901095



■ Float with brown hydro-absorbent sponge



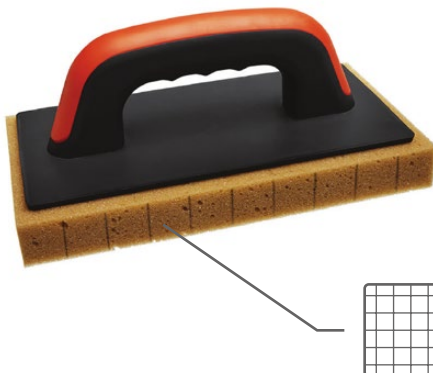

index	size	thickness		EAN
6041	130×250 mm	30 mm	12	 5 906554 513902
6623	140×280 mm	30 mm	12	 5 903076 901101

■ Float with brown, notched, hydro-absorbent sponge





index	size	thickness		EAN
6042	130×250 mm	30 mm	12	 5 906554 513919
6624	140×280 mm	30 mm	12	 5 903076 901118

Float with gray sponge

index	size	thickness		EAN
6038	130×250 mm	30 mm	12	 5 906554 518983
6625	140×280 mm	30 mm	12	 5 903076 901125



Float with black rubber

index	size	thickness		EAN
6043	130×250 mm	10 mm	20	 5 906554 513926
6626	140×280 mm	10 mm	16	 5 903076 901132



Float with white rubber

index	size	thickness		EAN
6109	130×250 mm	8 mm	20	 5 906554 518938



Float with rough red sponge

index	size	thickness		EAN
6108	130×250 mm	20 mm	12	 5 906554 518938





■ Tile cleaner with scouring pads

index	size	pad color		EAN
6058	120×250 mm	white + black	9	5 906554 513018

Non-woven pads [2-pack]

index	size	pad color		EAN
6055	120×250 mm	white + black	10	5 906554 515852
6056	120×250 mm	black	10	5 906554 515869
6233	120×250 mm	white	10	5 906554 519300



■ Grout float

index	size		EAN
6847	95×255 mm	6	5 903076 907493

■ Hand sander with white rubber

White foam base



index	size	thickness		EAN
6246	105×230 mm	4 mm	10	5 906554 519348





■ Abrasive float with sandpaper



index	size		EAN
6236	130×270 mm	20	5 906554 514718
6238	160×380 mm	10	5 906554 519867

■ Float with felt

index	size	felt thickness		EAN
5338	130×270 mm	4 mm	20	 5 906554 516842
5331	130×270 mm	8 mm	20	 5 906554 514848



■ Float with yellow hydro-absorbent sponge

index	size	thickness		EAN
5362	130×270 mm	20 mm	12	 5 906554 510109



■ Float with yellow, notched, hydro-absorbent sponge

index	size	thickness		EAN
5363	130×270 mm	20 mm	12	 5 906554 510093

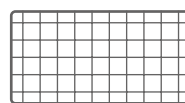

■ Float with yellow hydro-absorbent sponge Profi

index	size	thickness		EAN
5686	130×270 mm	25 mm	12	 5 906554 519324



■ Float with yellow, notched, hydro-absorbent sponge Profi



index	size	thickness		EAN
5686-2	130×270 mm	25 mm	12	 5 902891 286677

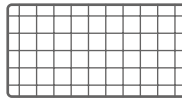

■ Float with brown hydro-absorbent sponge



index	size	thickness		EAN
5330	130×270 mm	30 mm	12	 5 906554 514831

■ Float with brown, notched, hydro-absorbent sponge



index	size	thickness		EAN
5337	130×270 mm	30 mm	12	 5 906554 512882

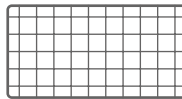

■ Float with graphite sponge



index	size	thickness		EAN
5329	130×270 mm	20 mm	12	 5 906554 514824

■ Float with rough red sponge

index	size	thickness		EAN
5332	130×270 mm	20 mm	12	 5 906554 514855



■ Float with black rubber

index	size	thickness		EAN
5424	130×270 mm	8 mm	20	 5 906554 517412



■ Hand sander

Black foam base

index	size	thickness		EAN
5367	100×220 mm	3 mm	30	 5 902891 286783



■ Fugownik

index	size		EAN
6187	150 mm	10	 5 906554 512066
6188	200 mm	10	 5 906554 512073
6189	250 mm	10	 5 906554 512080
6190	300 mm	10	 5 906554 512097



STAINLESS
STEEL



■ **Stainless stucco trowel h. 2C**

Stainless steel, acid-resistant, thickness: 0,8 mm

index	size		EAN
6139	60 mm	55	5 906554 514381
6140	80 mm	55	5 906554 514398
6141	100 mm	50	5 906554 514404
6142	120 mm	45	5 906554 514411

STAINLESS
STEEL



■ **Stainless bucket trowel h. 2C**

Stainless steel, acid-resistant, thickness: 1,0 mm

index	size		EAN
6206	55/80×140 mm	60	5 906554 518761
6122	90/110×140 mm	50	5 906554 514275
6123	85/115×160 mm	40	5 906554 514282
6124	90/120×180 mm	30	5 906554 514299

STAINLESS
STEEL



■ **Stainless inside corner trowel h. 2C**

Stainless steel, acid-resistant, thickness: 0,7 mm

index	size		EAN
6152	60×90 mm	25	5 906554 514473
6156	75×110 mm	25	5 906554 514510

STAINLESS
STEEL



■ **Stainless outside corner trowel h. 2C**

Stainless steel, acid-resistant, thickness: 0,7 mm

index	size		EAN
6153	60×90 mm	25	5 906554 514480
6157	75×110 mm	25	5 906554 514527

■ Stainless joint pointing trowel h. 2C

Stainless steel, acid-resistant, thickness: 1,0 mm

index	size		EAN
6163	8 mm	30	 5 906554 514602
6164	10 mm	30	 5 906554 514619
6165	12 mm	30	 5 906554 514626



STAINLESS
STEEL

■ Stainless narrow stucco trowel h. 2C

Stainless steel, acid-resistant, thickness: 1,0 mm

index	size		EAN
6166	160 mm	50	 5 906554 517719



STAINLESS
STEEL

■ Stainless wide stucco trowel h. 2C

Stainless steel, acid-resistant, thickness: 1,0 mm

index	size		EAN
6208	160 mm	50	 5 906554 514633



STAINLESS
STEEL

■ Stainless both side corner trowel h. 2C

Stainless steel, acid-resistant, thickness: 0,8 mm

index	size		EAN
6158	110 mm	25	 5 906554 518686



STAINLESS
STEEL

STAINLESS
STEEL



■ **Stainless stucco trowel h. wood**

Stainless steel, acid-resistant, thickness: 0,8 mm

index	size		EAN
6133	60 mm	65	5 906554 514336
6134	80 mm	60	5 906554 514343
6135	100 mm	55	5 906554 514350
6136	120 mm	50	5 906554 514367

STAINLESS
STEEL



■ **Stainless bucket trowel h. wood**

Stainless steel, acid-resistant, thickness: 1,0 mm

index	size		EAN
6207	55/80×140 mm	60	5 906554 518778
6119	90/110×140 mm	60	5 906554 514244
6120	85/115×160 mm	50	5 906554 514251
6121	90/120×180 mm	40	5 906554 514268

STAINLESS
STEEL



■ **Stainless inside corner trowel h. wood**

Stainless steel, acid-resistant, thickness: 0,7 mm

index	size		EAN
6150	60×90 mm	25	5 906554 514459
6154	75×110 mm	25	5 906554 514497

STAINLESS
STEEL



■ **Stainless outside corner trowel h. wood**

Stainless steel, acid-resistant, thickness: 0,7 mm

index	size		EAN
6151	60×90 mm	25	5 906554 514466
6155	75×110 mm	25	5 906554 514503

■ Stainless joint pointing trowel h. wood

Stainless steel, acid-resistant, thickness: 1,0 mm

index	size		EAN
6160	8 mm	30	 5 906554 514572
6161	10 mm	30	 5 906554 514589
6162	12 mm	30	 5 906554 514596



STAINLESS
STEEL

■ Stainless joint pointing trowel h. wood

Carbon steel, thickness: 1,0 mm

index	size		EAN
5357	8 mm	12	 5 903076 912008
5358	10 mm	12	 5 903076 912015
5359	12 mm	12	 5 903076 912022



CARBON
STEEL

■ Stainless both side corner trowel h. wood

Stainless steel, acid-resistant, thickness: 0,8 mm

index	size		EAN
6167	110 mm	25	 5 906554 514640



STAINLESS
STEEL

■ Stucco trowel h. wood

Welded trowel, ground on both sides, carbon steel, thickness: 1,2 mm

index	size		EAN
6131	80 mm	60	 5 906554 514312
6132	100 mm	55	 5 906554 514329



CARBON
STEEL

CARBON
STEEL



■ Bucket trowel h. wood

Welded trowel, ground on both sides, carbon steel, thickness: 1,2 mm

index	size	☐	EAN
6116	65/80×140 mm	60	5 906554 514213
6117	65/80×160 mm	50	5 906554 514220
6118	85/110×180 mm	40	5 906554 514237

CARBON
STEEL



■ Triangular trowel h. 2C

Welded trowel, carbon steel

index	size	☐	EAN
6643	180 mm	6	5 903076 901309
6644	200 mm	6	5 903076 901316
6645	220 mm	6	5 903076 901323

CARBON
STEEL



■ Triangular trowel h. wood

Welded trowel, carbon steel

index	size	☐	EAN
6640	180 mm	6	5 903076 901279
6641	200 mm	6	5 903076 901286
6642	220 mm	6	5 903076 901293

■ Trowel for cellular concrete



index	size	☐	EAN
6168	115 mm	10	5 902891 286042
6169	240 mm	10	5 902891 286059
6176	300 mm	8	5 902891 286127

■ Rasp for cellular concrete

index	size		EAN
6234	450 mm	10	 5 906554 515289



■ Wire twisting wrench

index			EAN
6379		50	 5 903076 907899



■ Stainless stucco trowel h. wood

Stainless steel, thickness: 0,65 mm

index	size		EAN
5380	60 mm	65	 5 906554 511151
5381	80 mm	60	 5 906554 511168
5382	100 mm	55	 5 906554 511175
5388	120 mm	50	 5 906554 517900



■ Stainless bucket trowel h. wood

Stainless steel, thickness: 0,8 mm

index	size		EAN
5383	55/80×140 mm	60	 5 906554 513292
5545	90/110×140 mm	60	 5 906554 517887
5384	85/115×160 mm	50	 5 906554 513308





■ **Triangular trowel h. wood**

Welded trowel, ground on both sides, carbon steel, thickness: 1,2 mm

index	size		EAN
5389	200 mm	10	5 906554 514671
5390	220 mm	10	5 906554 514688



■ **Triangular trowel h. wood**

Welded trowel, carbon steel, thickness: 1 mm

index	size		EAN
5401	180 mm	50	5 906554 517665



■ **Tile wedges**

index	size	packaging		EAN
6530	medium 15×43×87 mm	bag 20 pcs.	100	5 903076 900746
6531	big 24×43×135 mm	bag 20 pcs.	100	5 903076 903822
21568	medium 15×43×87 mm	box 200 pcs.	100	5 903076 904638
21624	big 24×43×135 mm	box 200 pcs.	100	5 903076 905437



■ **Silicone finishing tool set**

index		EAN
6378	200	5 903076 906403

■ Tile washing bucket 20 l

index		EAN
5444	10	 5 902891 286578



■ Tile washing set Mini

Zestaw zawiera: 

5444	Tile washing bucket 20 l	125
5445	Rollers	126
5446	Plastic grid	126

index		EAN
5997	1	 5 906554 516835



■ Tile washing set Standard

Zestaw zawiera: 

5444	Tile washing bucket 20 l	125
5445	Rollers	126
5446	Plastic grid	126
6042	Float with sponge	112
6847	Grout float	114

index		EAN
5440	1	 5 906554 512400



■ Zestaw glazurniczy Professional

Zestaw zawiera: 

5444	Tile washing bucket 20 l	125
5445	Rollers	126
5446	Plastic grid	126
6106	Float with sponge	112
6847	Grout float	114
6023	Stainless steel notch trowel 8 mm	103
6140	Stainless stucco trowel	118

index		EAN
5999	1	 5 902891 286615





Rollers for the tile washing bucket 20 l



index		EAN
5445	10	 5 902891 286585

Plastic grid for tile washing bucket 20 l



index		EAN
5446	20	 5 906554 513995

Wheels for the tile washing bucket 20 l [4 pcs.]



index		EAN
5447	10	 5 906554 510376

Hydro yellow sponge



index	size		EAN
6228	140×110×70 mm	20	 5 906554 519218

Hydro yellow sponge Premium

index	size		EAN
6229	140×110×70 mm	20	 5 906554 518990

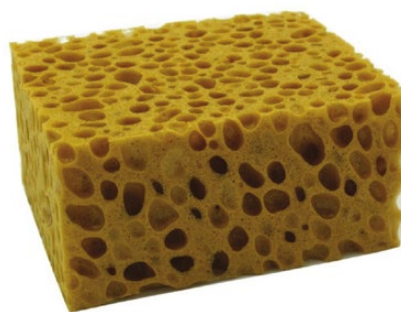

Hydro angled sponge

index	size		EAN
6079	160×90×60 mm	20	 5 906554 516071



Cellulose sponge

index	size		EAN
6227	150×110×60 mm	20	 5 906554 519669

 Designed for work with epoxy grouts



Hydro sponge

index	size		EAN
5356	140×110×70 mm	20	 5 906554 510505





■ Joint scrubber



index	size		EAN
5703	50 mm	10	 5 906554 517313

■ Spiked shoes



index		EAN
5448	10	 5 906554 510383

■ Self-adhesive screed flooring height markers



index	height		EAN
6619	6 cm	10	 5 903076 912718

■ Deaeration roller

index	size	spike height		EAN
5663	25 cm / ∅ 73 mm	14 mm	5	 5 902891 286721



■ Deaeration roller

index	size	spike height		EAN
5664	25 cm / ∅ 100 mm	28 mm	5	 5 902891 286738



■ Deaeration roller

index	size	spike height		EAN
5666	50 cm / ∅ 100 mm	28 mm	1	 5 902891 286752





■ Mixing paddle for mortar

index	size		EAN
5403	80 mm	10	 5 906554 510512
5404	100 mm	10	 5 906554 510529
5405	120 mm	10	 5 906554 511281



■ Mixing paddle for mortar with M14 screw

index	size		EAN
5412	120 mm	10	 5 906554 511618
5415	140 mm	10	 5 906554 512042
5416	160 mm	10	 5 906554 510598



■ Mixing paddle for mortar SDS

index	size		EAN
5417	80 mm	10	 5 903076 908940
5414	100 mm	10	 5 906554 512028
5413	120 mm	10	 5 906554 513537



■ Mixing paddle for mortar with M14 screw

index	size		EAN
5418	120 mm	10	 5 903076 900869
5400	140 mm	10	 5 906554 511090

■ Mixing paddle for plastering mortar with M14 screw

index	size		EAN
5402	140 mm	10	 5 906554 518723



M14



■ Mixing paddle for plastering mortar

index	size		EAN
5406	80 mm	10	 5 906554 510574
5407	100 mm	10	 5 906554 510581



HEX



■ Mixing paddle for paints

index	size		EAN
5408	80 mm	10	 5 906554 510536
5409	100 mm	10	 5 906554 510543



HEX



■ Mixing paddle for paints Profi

index	size		EAN
5524	60 mm	10	 5 906554 518426
5525	80 mm	10	 5 906554 518433
5419	100 mm	10	 5 903076 900876



HEX





■ Universal round bucket

index	capacity	EAN
5317	15 l	5 906554 515760
5426	33 l	5 906554 517450



■ Lid for universal bucket

index	capacity	EAN
5320	15 l	5 906554 519225
5427	33 l	5 906554 517474



■ Bucket

index	capacity	EAN
5430	5 l	5 902891 286790
5431	12 l	5 902891 286806
5432	16 l	5 902891 286813
5433	20 l	5 902891 286820



■ Rectangular building container

index	capacity	EAN
5434	40 l	5 902891 286837
5435	60 l	5 902891 286844
5436	80 l	5 902891 286851

■ Round building container

index	capacity	EAN
5437	45 l	5 902891 286868
5438	65 l	5 902891 286875
5439	90 l	5 902891 286882



■ Plaster container

index		EAN
6182	50	5 906554 512806



■ Abrasive sponge

index	granulacja		EAN
5498	P46	10	5 903076 908827
5458	P60	10	5 906554 512592
5500	P80	10	5 906554 513575
5459	P100	10	5 906554 512608
5501	P120	10	5 906554 513582
5502	P150	10	5 906554 515326
5503	P180	10	5 906554 515333
5499	P220	10	5 906554 516989



■ Angled abrasive sponge



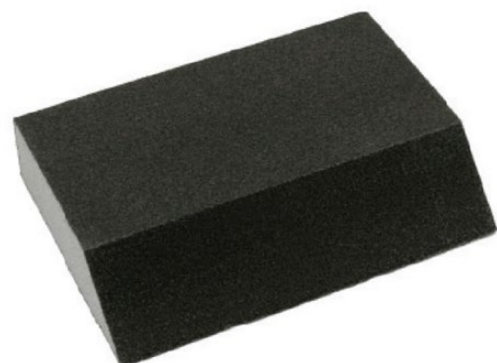



index	granulacja		EAN
5512	P46	10	5 903076 908834
5513	P60	10	5 903076 908841
5505	P80	10	5 906554 516729
5515	P100	10	5 906554 518860
5506	P120	10	5 906554 516736
5516	P150	10	5 906554 518877
5517	P180	10	5 903076 908865
5514	P220	10	5 903076 908858



■ Sanding screen

Size 105×265 mm





index	grit	packaging		EAN
5450	P46	pack 5 pcs.	50	 5 906554 515876
5451	P60	pack 5 pcs.	50	 5 906554 515883
5452	P80	pack 5 pcs.	50	 5 906554 515890
5453	P100	pack 5 pcs.	50	 5 906554 515906
5454	P120	pack 5 pcs.	50	 5 906554 515913
5455	P150	pack 5 pcs.	50	 5 906554 515920
5456	P180	pack 5 pcs.	50	 5 906554 515937
5457	P220	pack 5 pcs.	50	 5 906554 515944

■ Abrasive discs with velcro 3 pcs.

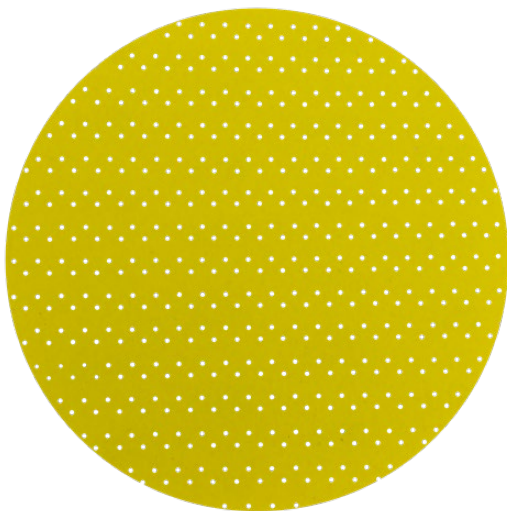
Diameter: 225 mm



index	grit		EAN
6191	P40	50	 5 906554 515388
6192	P60	50	 5 906554 515395
6193	P80	50	 5 906554 515401
6194	P100	50	 5 906554 515517
6195	P120	50	 5 906554 515524
6196	P150	50	 5 906554 515449
6197	P180	50	 5 906554 515456
6198	P220	50	 5 906554 515463

■ Sanding cloth

Size: 230×280 mm

index	grit		EAN
5507	P24	50	5 908211 722030
5508	P36	50	5 908211 722047
5469	P40	50	5 908211 722054
5470	P60	50	5 908211 722061
5471	P80	50	5 908211 722078
5472	P100	50	5 908211 722085
5473	P120	50	5 908211 722092
5474	P150	50	5 908211 722108
5475	P180	50	5 908211 722115
5476	P220	50	5 908211 722122
5477	P240	50	5 908211 722139

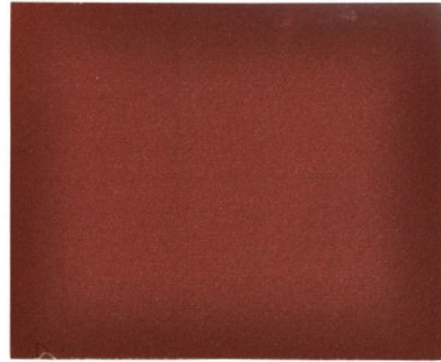

■ Sandpaper in roll YELLOW

Roll width: 115 mm

index	grit		EAN
5478	P40	50 lm	5 908211 722498
5479	P60	50 lm	5 908211 722504
5480	P80	50 lm	5 908211 722511
5481	P100	50 lm	5 908211 722528
5482	P120	50 lm	5 908211 722535
5483	P150	50 lm	5 908211 722542
5484	P180	50 lm	5 908211 722559
5494	P220	50 lm	5 908211 722566
5529	P40	5 lm	5 906554 515982
5530	P60	5 lm	5 906554 515999
5531	P80	5 lm	5 906554 516002
5532	P100	5 lm	5 906554 516019
5533	P120	5 lm	5 906554 516026
5534	P150	5 lm	5 906554 516033
5535	P180	5 lm	5 906554 516040



■ Sandpaper disc with velcro

Diameter: 125 mm



index	grit		EAN
5509	P24	50	5 903076 901989
5485	P36	50	5 906554 516606
5486	P40	50	5 906554 516613
5487	P60	50	5 906554 516620
5488	P80	50	5 906554 516637
5489	P100	50	5 906554 516644
5490	P120	50	5 906554 516651
5491	P150	50	5 906554 516668
5492	P180	50	5 906554 516675
5493	P220	50	5 906554 516682

■ Holder for sandpaper disc

Diameter: 125 mm



index	type		EAN
5496	without pin	10	5 906554 517726
5497	with pin	10	5 906554 517733

■ Masonry line



index	length		EAN
5623	100 lm	100	5 906554 517573

■ Masonry line

index	length		EAN
6545	50 lm	100	 5 903076 905949
6546	100 lm	50	 5 903076 905956
6547	150 lm	64	 5 903076 913333

NO STRETCHING



■ Masonry line on spool

index	length		EAN
6544	100 lm	96	 5 903076 910347







■ Masonry line

index	length		EAN
5680	50 lm	20	 5 906554 512417
5681	100 lm	20	 5 906554 512424



■ Twine

index	length		EAN
5575	200 lm	12	 5 906554 517924
5576	400 lm	6	 5 906554 517931
5577	1000 lm	2	 5 906554 517948
5578	2000 lm	1	 5 906554 517955



DESIGN YOUR OWN DISPLAY OR USE A READY-MADE SOLUTION

We offer our clients professional shelving systems for our products. They are characterized by large capacity and high aesthetics.

Our representative will help you choose the optimal solution for your needs. Below are some of the most popular display examples.

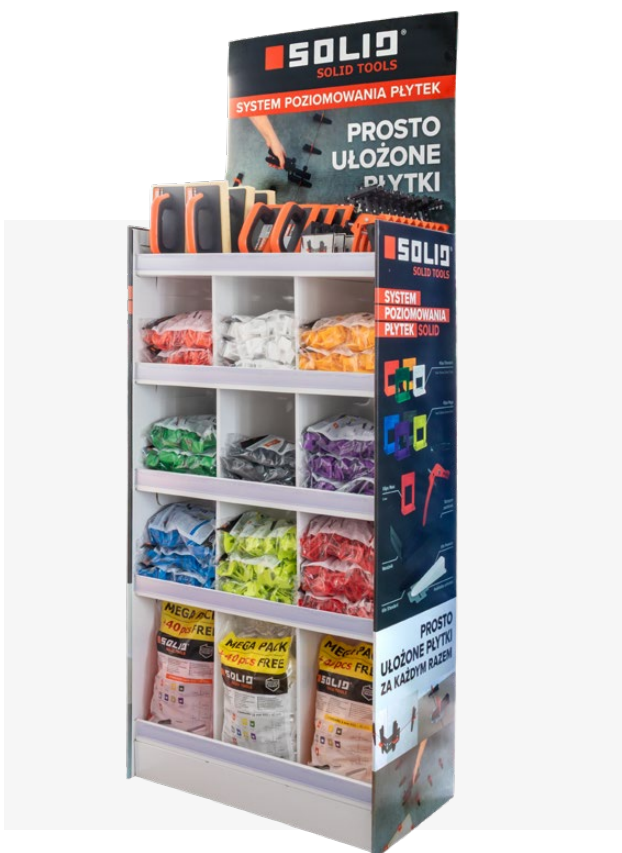

1 Display for the tile leveling system

↓ 196 cm ↓ 60 cm ↓ 45 cm



2 Display for skimming spatulas

↓ 156 cm ↓ 69 cm ↓ 47 cm

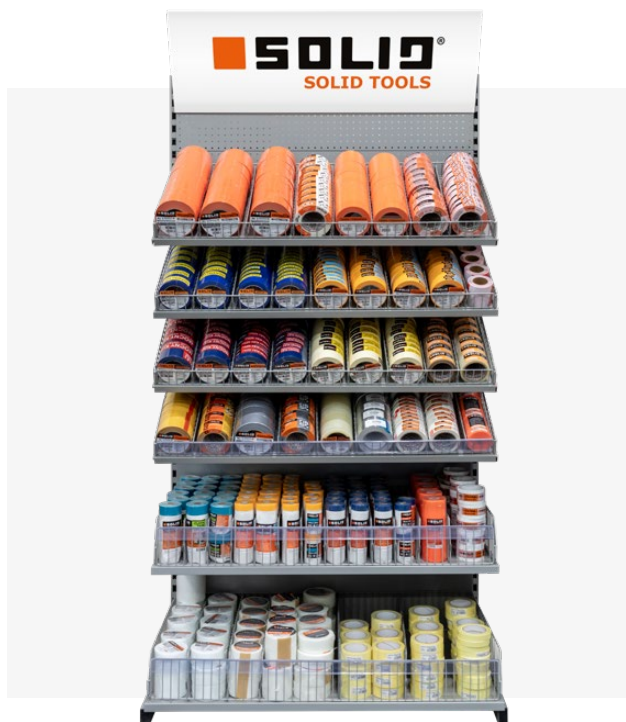

3 Masking tapes

↓ 230 cm ↓ 120 cm ↓ 70 cm



4 Painting display

↓ 230 cm ↓ 240 cm (2x120 cm) ↓ 70 cm



5 Tools display

↓ 230 cm ↓ 240 cm (2x120 cm) ↓ 70 cm

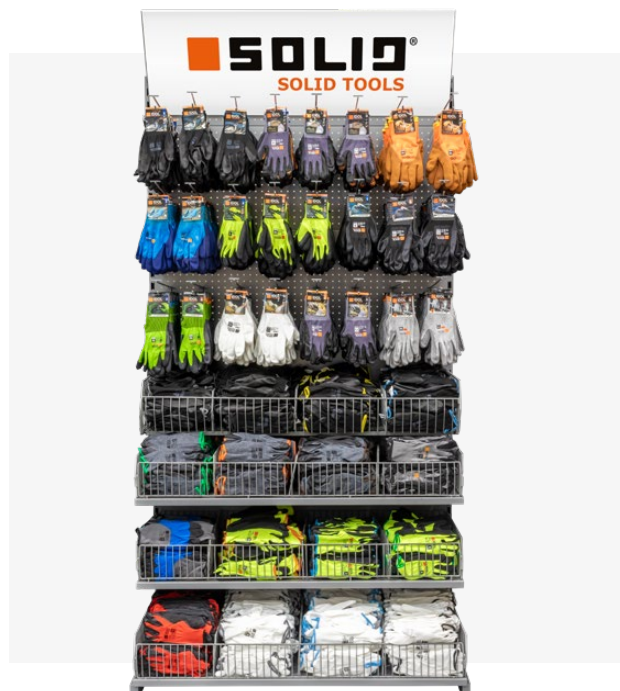

6 Gloves display

↓ 230 cm ↓ 120 cm ↓ 70 cm



7

Rotating display for gloves

↓ 200 cm 85 cm 70 cm



Example display, 7 shelves

↓ 230 cm ↓ 840 cm ↓ 70 cm



Example display, 7 shelves

↑ 230 cm ⊞ 840 cm ⊞ 70 cm

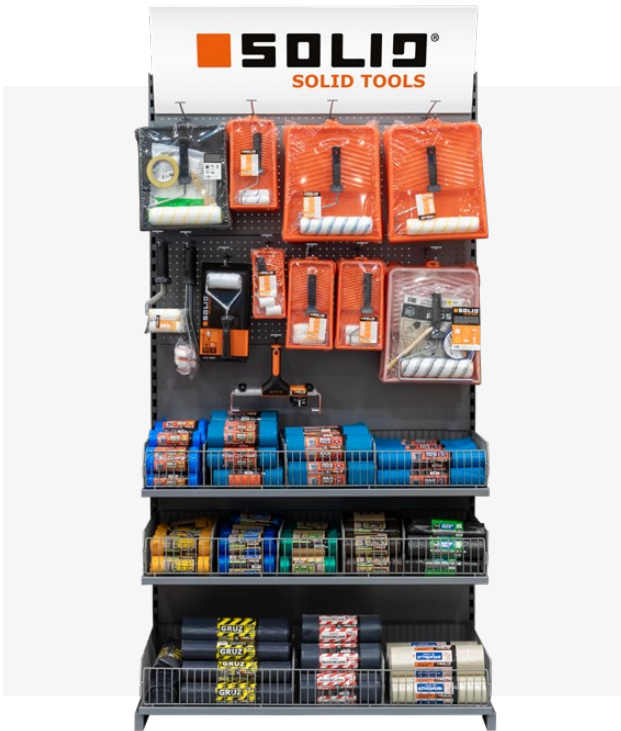

8

Painting and bags display

↓ 230 cm ↓ 120 cm ↓ 70 cm

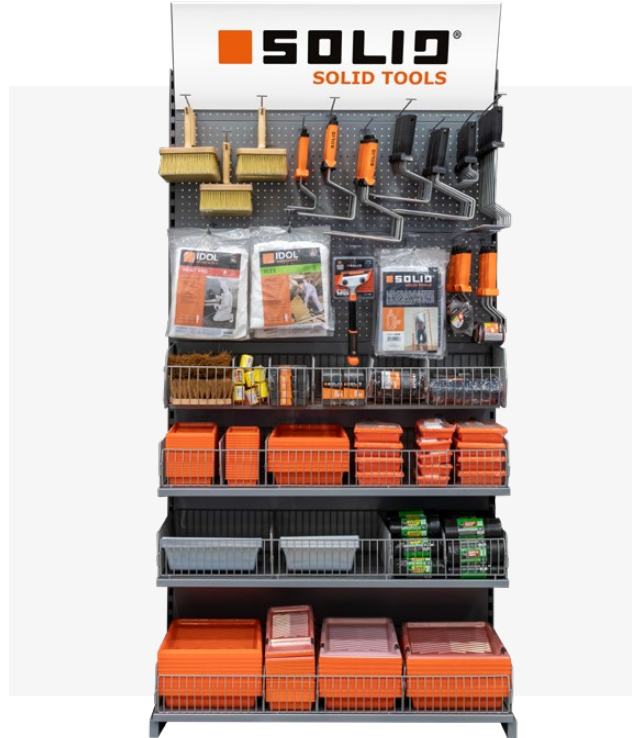

9

Painting display

↓ 230 cm ↓ 120 cm ↓ 70 cm



10

Bags display

↓ 230 cm ↓ 60 cm ↓ 70 cm



11

Masking tapes display

↓ 195 cm ↓ 42 cm ↓ 40 cm



12

Blister with measure tape



13

Cardboard with measure tapes



14

Blister with snap-off blade knife



15

Cardboard with snap-off blade knives



FHU PARTNER



+48 (58) 691 08 05
+48 508 856 289

info@solidtools.pl
f SolidToolsPl

www.solidtools.pl



1 Sales office and production plant
ul. Poczтова 32, 83-034 Trąbki Wielkie



2 Production plant
ul. Dekarska 2, 83-031 Rusocin