



**POLSKI PRODUCENT  
NARZĘDZI BUDOWLANYCH  
I AKCESORIÓW MALARSKICH**

# **SOLID**® **SOLID TOOLS**

**KATALOG  
2026**



■ SOLID ■ ECONOMIC SERIES

O firmie	2
■ System poziomowania płytek	4
■ Przyssawki	14
■ Nakolanniki	15
■ Rękawice	16
■ Kombinezony i polary	24
■ Markery i ołówki	26
■ Noże i ostrza	30
■ Miary	37
■ Podpory teleskopowe	39
■ Pędzle	40
■ Rączki malarskie	46
■ Kije teleskopowe	49
■ Kuwety malarskie	50
■ Wałki i zestawy malarskie	54
■ Taśmy elewacyjne i malarskie	63
■ Worki	76
■ Folie ochronne	79
■ Noże do gładzi	86
■ Szpachle	92
■ Pace	98
■ Kielnie	118
■ Narzędzia glazurnicze	125
■ Mieszadła	130
■ Pozostałe produkty	132
■ Ekspozycja	138

# SPIS TREŚCI

## O FIRMIE

### ABOUT THE COMPANY

Nasza firma rozpoczęła działalność w 2001 roku. Posiadamy własne zakłady produkcyjne zlokalizowane w okolicy Gdańska, w których powstają ręczne narzędzia budowlane, systemy poziomowania płytek, artykuły malarskie i produkty foliowe. Poprzez własny dział handlowy zaopatrujemy ponad 2500 marketów i składów budowlanych na terenie Polski i Europy. Jako firma zawsze staramy się budować długoterminową współpracę, której bazą jest wzajemne zaufanie oraz odpowiedzialność.

Zapraszamy do współpracy.

Our company was founded in 2001. We have our own production plants located near Gdansk where hand construction tools, tile leveling systems, painting tools and foil products are manufactured.

Through our own sales department we supply over 2500 DIY stores and construction warehouses in Poland and Europe. As a company we always try to build a long-term cooperation with our customers, based on the trust, honest and responsibility.

We are looking forward to doing business with you.

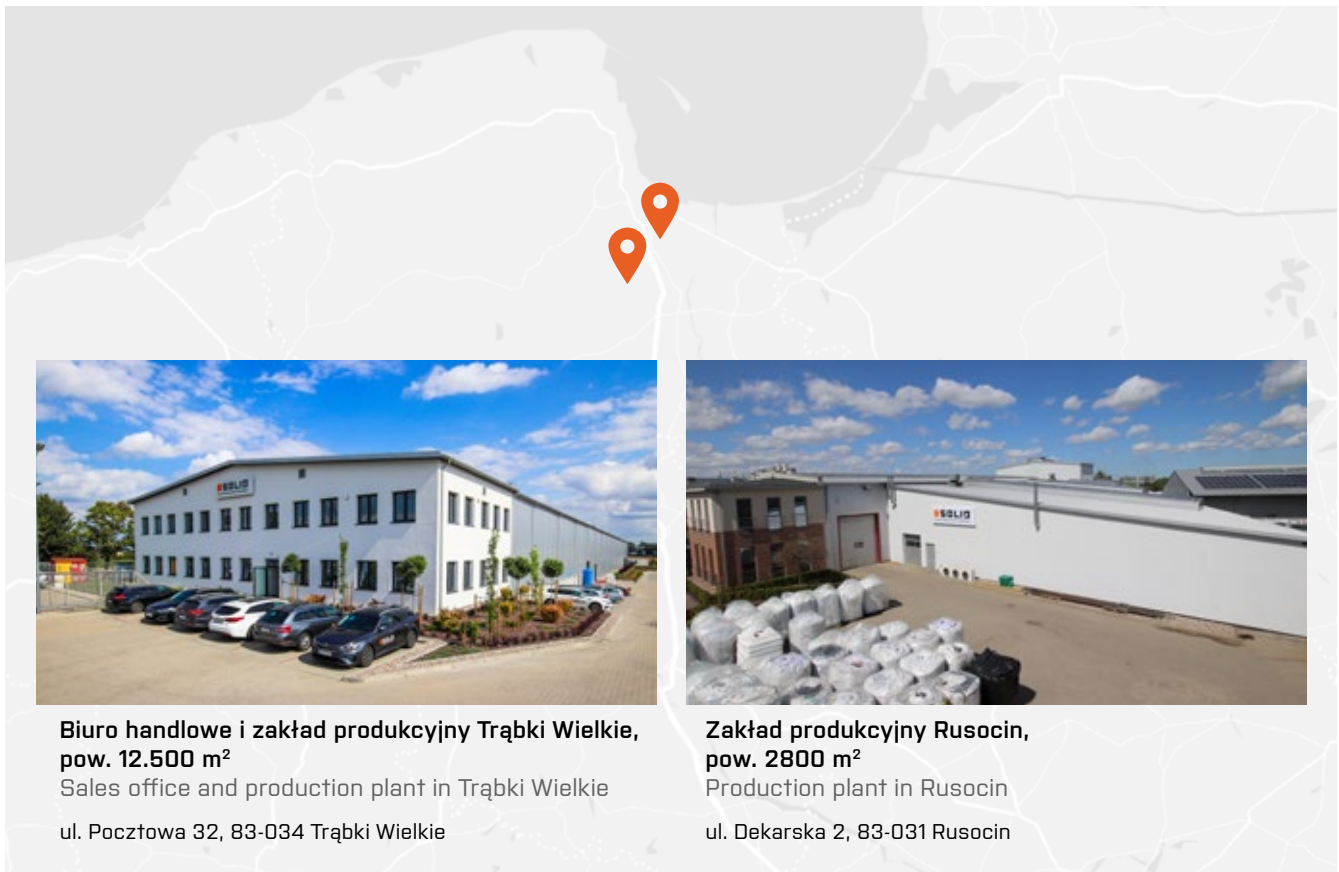

 **SOLID**  
SOLID TOOLS

Produkty pod marką SOLID przeznaczone są dla profesjonalnych wykonawców budowlanych, którzy doceniają wysoką jakość i niezawodność używanych narzędzi. Do produkcji naszych wyrobów używamy wyłącznie najwyższej jakości komponentów, takich jak stal pochodząca z renomowanych europejskich hut czy wysokogatunkowe tworzywa sztuczne. Proces produkcji jest stale monitorowany, dzięki czemu uzyskujemy produkty najwyższej jakości.

Products under the SOLID brand are designed for professional building contractors who appreciate the high quality and reliability of the tools. For the production of our products we use only the highest quality components such as steel from renowned European producers and high quality plastics. The production process is constantly monitored thanks to which we obtain products of the highest quality.



# SYSTEM POZIOMOWANIA PŁYTEK

**nr 1** NAJWYŻSZA JAKOŚĆ



DOBIERZ WŁAŚCIWE ELEMENTY SYSTEMU **SOLID**:





<p><b>Klips STANDARD</b> do płytek o grubości od 3mm do 16mm</p> <p>1 mm      1,5 mm      2 mm      3 mm</p>				<p><b>Klips MAXI</b> do płytek o grubości od 25mm do 36mm</p> <p>3 mm</p>	
<p><b>Klips MEGA</b> dla płytek o grubości od 15mm do 26mm</p> <p>1 mm      1,5 mm      2 mm      3 mm</p>				<p><b>Szczypce zaciskowe</b></p>	
<p><b>Narożnik</b></p>	<p><b>Podkładka pod klin</b></p>	<p><b>Klin STANDARD</b></p>	<p><b>Klin PREMIUM</b></p>		

DOBIERZ ILOŚĆ POTRZEBNYCH KLIPSÓW:

plytka	25x40	33x33	40x40	45x45	50x50	60x60	60x30	80x80	100x50	120x60
sztuki / m <sup>2</sup>	38	32	24	18	14	10	22	6	6	5

**Klips Standard 100 szt.**

Dedykowane do płytek o grubości od 3 do 16 mm.

index	szer. fugi	typ		EAN	klips
6358	1 mm	standard	10	5 906554 511205	
6460	1,5 mm	standard	10	5 903076 908216	
6461	2 mm	standard	10	5 903076 908223	
6462	3 mm	standard	10	5 903076 908230	



IDEALNY DO GRUBOŚCI PŁYTEK:



**Klips Mega 100 szt.**

Dedykowane do płytek o grubości od 15 do 26 mm.  
Idealne do gresu o grubości 2 cm.

index	szer. fugi	typ		EAN	klips
6493	1 mm	mega	10	5 903076 905239	
6494	1,5 mm	mega	10	5 903076 905246	
6495	2 mm	mega	8	5 903076 905253	
6496	3 mm	mega	8	5 903076 905260	



IDEALNY DO GRUBOŚCI PŁYTEK:





■ Klips Maxi 100 szt.

Dedykowane do płytek o grubości od 25 do 36 mm.  
Idealne do gresu o grubości 3 cm.

index	szer. fugi	typ		EAN	klips
6497	3 mm	maxi	6	5 903076 905277	

IDEALNY DO GRUBOŚCI PŁYTEK:

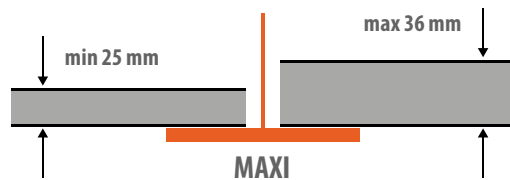





**+ 40szt.  
GRATIS!**

■ Klips Standard 400 + 40 szt.

index	szer. fugi	typ		EAN	klips
6465	1 mm	standard	2	5 903076 900128	
6466	1,5 mm	standard	2	5 903076 900166	
6467	2 mm	standard	2	5 903076 900210	
6468	3 mm	standard	2	5 903076 902641	

■ Klips Standard 400 + 40 szt.





index	szer. fugi	typ		EAN	klips
6470	1 mm	standard	4	5 903076 900784	
6471	1,5 mm	standard	4	5 903076 900791	
6472	2 mm	standard	4	5 903076 900807	
6473	3 mm	standard	4	5 903076 900814	



**+  
40szt.  
GRATIS!**

■ Klips Standard 800 szt. + wiadro 20L

Wytrzymałe wiadro z podziałką o pojemności 20L do wielokrotnego użytku.

index	szer. fugi	typ		EAN	klips
6451	1 mm	standard	1	5 903076 907356	
6452	1,5 mm	standard	1	5 903076 907363	
6453	2 mm	standard	1	5 903076 907370	



■ **Klin standard**



index	ilość	opakowanie		EAN
6359	50 szt.	worek	10	5 906554 511212
6459	100 szt.	wiadro	4	5 903076 900227

■ **Klin premium**



index	ilość	opakowanie		EAN
6456	50 szt.	worek	10	5 903076 900715

■ **Szczypce zaciskowe**

Gwarantują szybki montaż, precyzyjny docisk i perfekcyjny efekt końcowy. Dzięki solidnej konstrukcji i regulowanemu mechanizmowi docisku uzyskasz równe fugi bez wysiłku. Idealne zarówno dla profesjonalistów, jak i majsterkowiczów.



index		EAN
6464	10	5 903076 908209

■ Klips Standard 100 szt. + klin 50 szt. + szczypce

index	rozmiar	typ		EAN
6356	1 mm	standard	4	5 903076 900111











■ Klips Standard 100 szt. + klin 50 szt.

index	rozmiar	typ		EAN
6357	1 mm	standard	4	5 906554 511199







**DOBIERZ WŁAŚCIWE ELEMENTY SYSTEMU MINI:**

<b>Klips</b> fuga 1 mm 	<b>Klips</b> fuga 1,5 mm 	<b>Klips</b> fuga 2 mm 	<b>Klips</b> fuga 3 mm 	<b>Szczypce zaciskowe</b> 
<b>Podkładka pod klin</b> 		<b>Klin</b> 	<b>Narożnik</b> 	



**■ Klips mini 100 szt.**

Do wąskich kafli lub płytek o małych rozmiarach. Zapewniają wysoką jakość standardowego systemu poziomowania płytek SOLID, lecz dzięki mniejszym rozmiarom zapewniają większy komfort pracy przy ograniczonej przestrzeni. Dedykowane do płytek o grubości od 4 do 12 mm

index	szer. fugi	typ		EAN	klips
6960	1 mm	mini	12	5 903076 913562	
6961	1,5 mm	mini	12	5 903076 913579	
6962	2 mm	mini	12	5 903076 913586	
6963	3 mm	mini	12	5 903076 913593	

**■ Klin mini**

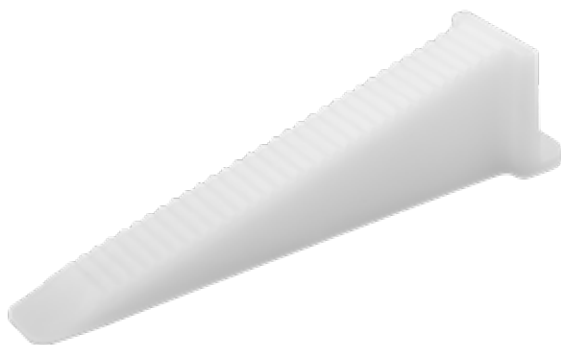
index	ilość	opakowanie		EAN
6964	50 szt.	worek	20	5 903076 913609



**Podkładka pod klin 50 szt.**

Idealna do zabezpieczania delikatnych płytek przed zarysowaniem

index		EAN
6457	12	 5 903076 900616



**Narożnik do glazury 10 szt.**

index		EAN
6458	16	 5 903076 900579



**Krzyżyki dystansowe gwiazdki**

Szerokość fugi: 1,0; 1,5; 2,0; 2,5 i 3,0 mm

index	opakowanie		EAN
6492	50 szt.	160	 5 903076 911940



**Krzyżyki dystansowe MULTI**



index	rozmiar	opakowanie	kolor		EAN
6488	1,0 mm	50 szt.	 	80	 5 903076 911902
6489	1,5 mm	50 szt.	 	80	 5 903076 911919
6490	2,0 mm	50 szt.	 	80	 5 903076 911926
6491	3,0 mm	50 szt.	 	80	 5 903076 911933





**■ Krzyżyki dystansowe**

index	rozmiar	opakowanie		EAN
5599	1 mm	150 szt.	50	 5 906554 511922
5600	1,5 mm	150 szt.	50	 5 906554 513094
5601	2 mm	150 szt.	50	 5 906554 513100
5602	2,5 mm	150 szt.	50	 5 906554 513117
5603	3 mm	125 szt.	50	 5 906554 513124
5604	3,5 mm	100 szt.	50	 5 906554 513131
5605	4 mm	100 szt.	50	 5 906554 513148
5606	5 mm	75 szt.	50	 5 906554 513155
5607	6 mm	50 szt.	50	 5 906554 513162
5608	8 mm	30 szt.	50	 5 906554 513179
5609	10 mm	30 szt.	50	 5 906554 513186

**■ Kliny**

index	rozmiar	opakowanie		EAN
5610	mały	100 szt.	50	 5 906554 513193
5611	duży	50 szt.	50	 5 906554 513209

**■ Teowniki**

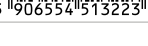
index	rozmiar	opakowanie		EAN
5616	6 mm	50 szt.	50	 5 906554 513322
5612	8 mm	30 szt.	50	 5 906554 513216
5613	10 mm	30 szt.	50	 5 906554 513223

**DOBIERZ WŁAŚCIWE ELEMENTY SYSTEMU KARO:**



■ Klips 100 szt.

index	rozmiar		EAN
5911	1 mm	10	5 903076 900067
5912	1,5 mm	10	5 903076 900074
5913	2 mm	10	5 903076 901033
5914	3 mm	10	5 903076 901040



■ Klin 50 szt.

index		EAN
5910	10	5 903076 900050







# PRZYSSAWKI



## ■ Przyssawka z manometrem

Uchwyt z manometrem do szyb i płytek, średnica przyssawki 200 mm, udźwig do 200 kg. Wyposażony w manometr do kontroli podciśnienia. Przeznaczony do przenoszenia gładkich, nieporowatych powierzchni

index	udźwig	średnica		EAN
6374	200 kg	200 mm	10	 5 903076 913043



## ■ Przyssawka podwójna aluminiowa



Aluminiowa konstrukcja, maks. udźwig 100 kg

index	udźwig	średnica		EAN
6375	100 kg	2x 118 mm	24	 5 903076 913050



## ■ Przyssawka pojedyncza

Plastikowa konstrukcja, maks. udźwig 40 kg

index	udźwig	średnica		EAN
6376	40 kg	118 mm	40	 5 903076 913067

# NAKOLANNIKI



## ■ Nakolanniki żelowe na rzep IDOL

Nierysująca powierzchnia, wsparcie kolana, podwójne mocowanie

index		EAN
82000	10	5 903076 911209



## ■ Nakolanniki IDOL

Przeznaczone do ciężkich prac, wytrzymałe, wygodne mocowanie

index		EAN
82001	10	5 903076 911216



## ■ Nakolanniki piankowe IDOL

Praktyczne i uniwersalne

index		EAN
82002	36	5 903076 911223



## ■ Nakolanniki wkładki IDOL

Wkładki do spodni roboczych

index		EAN
82003	36	5 903076 911230





# RĘKAWICE



## ■ Rękawice IDOL ND60

- Wytrzymała mikropianka nitylowa
- Kropki zwiększające przyczepność
- Tkanina nylon + spandex – idealne dopasowanie do dłoni

index	rozmiar	opak.		EAN
80119	6/XS	blister	12/120	5 903076 911247
80120	7/S	blister	12/120	5 903076 908360
80121	8/M	blister	12/120	5 903076 906601
80122	9/L	blister	12/120	5 903076 906618
80123	10/XL	blister	12/120	5 903076 906625
80124	11/XXL	blister	12/120	5 903076 906632



## ■ Rękawice IDOL NS60

- Wytrzymała mikropianka nitylowa
- Precyzyjny chwyt
- Tkanina nylon + spandex – idealne dopasowanie do dłoni

index	rozmiar	opak.		EAN
80131	8/M	blister	12/120	5 903076 906649
80132	9/L	blister	12/120	5 903076 906656
80133	10/XL	blister	12/120	5 903076 906663
80134	11/XXL	blister	12/120	5 903076 906670

### ■ Rękawice IDOL SPIDER

- Wytrzymała pianka lateksowa
- Struktura poprawiająca chwyt
- Tkanina nylon + spandex – idealne dopasowanie do dłoni

index	rozmiar	opak.		EAN
80190	7/S	blister	12/120	 5 903076 908483
80186	8/M	blister	12/120	 5 903076 907431
80187	9/L	blister	12/120	 5 903076 907448
80188	10/XL	blister	12/120	 5 903076 907455
80189	11/XXL	blister	12/120	 5 903076 907462







### ■ Rękawice IDOL AC5

- Wytrzymała antyprzecięciowa powłoka poliuretanowa
- Rękawice antyprzecięciowe w klasie C
- Tkanina poliestrowa + spandex – idealne dopasowanie do dłoni



SAFE CUT

index	rozmiar	opak.		EAN
81197	9/L	blister	12/120	 5 903076 910516
81198	10/XL	blister	12/120	 5 903076 910523
81199	11/XXL	blister	12/120	 5 903076 910530



### ■ Rękawice IDOL LX80

- Struktura poprawiająca chwyt
- Wysoka gramatura
- Tkanina poliestrowa

index	rozmiar	opak.		EAN
80202	9/L	blister	12/120	 5 903076 910646
80203	10/XL	blister	12/120	 5 903076 910653



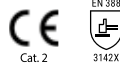

**■ Rękawice IDOL CG65**

- Powłoka z marszczonego lateksu
- Wysoka gramatura
- Tkanina poliestrowa

index	rozmiar	opak.		EAN
80106	8/M	worek	12/240	5 903076 906526
80107	9/L	worek	12/240	5 903076 906533
80108	10/XL	worek	12/240	5 903076 906540
80109	11/XXL	worek	12/240	5 903076 906557
80111	8/M	blister	12/240	5 903076 906564
80112	9/L	blister	12/240	5 903076 906571
80113	10/XL	blister	12/240	5 903076 906588
80114	11/XXL	blister	12/240	5 903076 906595



**■ Rękawice IDOL FY55**

- Powłoka ze spienionego lateksu
- Lekkość i komfort podczas noszenia
- Tkanina poliestrowa

index	rozmiar	opak.		EAN
80166	8/M	worek	12/240	5 903076 906793
80167	9/L	worek	12/240	5 903076 906809
80168	10/XL	worek	12/240	5 903076 906816
80169	11/XXL	worek	12/240	5 903076 906823
80172	8/M	blister	12/240	5 903076 906830
80173	9/L	blister	12/240	5 903076 906847
80174	10/XL	blister	12/240	5 903076 906854
80175	11/XXL	blister	12/240	5 903076 906861



**■ Rękawice IDOL FA75**





- Gładka powłoka lateksowa + pianka lateksowa
- Wodoodporne
- Tkanina poliestrowa



index	rozmiar	opak.		EAN
80161	9/L	blister	12/120	5 903076 906779
80162	10/XL	blister	12/120	5 903076 906786

### ■ Rękawice IDOL DH95

- Powłoka z marszczonego lateksu
- Ochrona najwyższej jakości
- Wysokiej jakości bawełna



index	rozmiar	opak.		EAN
80147	9/L	blister	12/120	 5 903076 906731
80148	10/XL	blister	12/120	 5 903076 906748
80149	11/XXL	blister	12/120	 5 903076 906755



### ■ Rękawice IDOL FV90

- Wytrzymała pianka lateksowa
- Gruby materiał frotte
- Komfort podczas pracy w zimnie





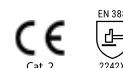





index	rozmiar	opak.		EAN
80152	10/XL	blister	12/120	 5 903076 906762



### ■ Rękawice IDOL PW30

- Wytrzymała powłoka poliuretanowa
- Cienka rękawica o dużej precyzji
- Tkanina poliestrowa

index	rozmiar	opak.		EAN
80177	8/M	worek	12/240	 5 903076 906878
80178	9/L	worek	12/240	 5 903076 906885
80179	10/XL	worek	12/240	 5 903076 906892
80180	11/XXL	worek	12/240	 5 903076 906908
80182	8/M	blister	12/240	 5 903076 906915
80183	9/L	blister	12/240	 5 903076 906922
80184	10/XL	blister	12/240	 5 903076 906939
80185	11/XXL	blister	12/240	 5 903076 906946

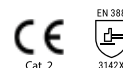

**■ Rękawice IDOL PK35**

- Wytrzymała powłoka poliuretanowa
- Cienka rękawica o dużej precyzji
- Tkanina poliestrowa

index	rozmiar	opak.		EAN
80206	8/M	worek	12/240	5 903076 910684
80207	9/L	worek	12/240	5 903076 910691
80208	10/XL	worek	12/240	5 903076 910707
80209	11/XXL	worek	12/240	5 903076 910714
80211	8/M	blister	12/240	5 903076 910738
80212	9/L	blister	12/240	5 903076 910745
80213	10/XL	blister	12/240	5 903076 910752
80214	11/XXL	blister	12/240	5 903076 910769

**■ Rękawice IDOL CR50**

- Powłoka z marszczonego lateksu
- Tkanina poliestrowa

index	rozmiar	opak.		EAN
80100	7/S	worek	12/240	5 903076 912985
80101	8/M	worek	12/240	5 903076 906489
80102	9/L	worek	12/240	5 903076 906496
80103	10/XL	worek	12/240	5 903076 906502
80104	11/XXL	worek	12/240	5 903076 906519
80115	8/M	worek z metką	12/240	5 903076 911957
80116	9/L	worek z metką	12/240	5 903076 911964
80117	10/XL	worek z metką	12/240	5 903076 911971
80118	11/XXL	worek z metką	12/240	5 903076 911988





**■ Rękawice IDOL LB58**

- Wytrzymała powłoka z lateksu
- Podwójna powłoka ochronna
- Cienka rękawica o dużej precyzji
- Tkanina poliestrowa

index	rozmiar	opak.		EAN
80191	7/S	worek	12/120	5 903076 908490
80192	8/M	worek	12/120	5 903076 908506
80193	9/L	worek	12/120	5 903076 908513
80194	10/XL	worek	12/120	5 903076 908520
80195	11/XXL	worek	12/120	5 903076 908537

### ■ Rękawice IDOL DL80





- Powłoka z marszczonego lateksu
- Podstawowa ochrona
- Oddychająca tkanina z naturalnej bawełny

index	rozmiar	opak.		EAN
80136	8/M	worek	12/240	 5 903076 906687
80137	9/L	worek	12/240	 5 903076 906694
80138	10/XL	worek	12/240	 5 903076 906700
80139	11/XXL	worek	12/240	 5 903076 906717



### ■ Rękawice nitrylowe IDOL STANDARD







- Bezpudrowe
- Odporne na rozdarcia

index	rozmiar	opak.		EAN
80226	8-9/L	karton	50	 5 903076 913449
80227	9-10/XL	karton	50	 5 903076 913456
80228	10-11/XXL	karton	50	 5 903076 913463
80231	8-9/L	blister	10	 5 903076 913470
80232	9-10/XL	blister	10	 5 903076 913487
80233	10-11/XXL	blister	10	 5 903076 913494



### ■ Rękawice nitrylowe IDOL POWER





- Grube i wytrzymałe
- Bezpudrowe
- Przedłużony mankiet

index	rozmiar	opak.		EAN
80236	8-9/L	karton	50	 5 903076 913500
80237	9-10/XL	karton	50	 5 903076 913517
80238	10-11/XXL	karton	50	 5 903076 913524
80241	8-9/L	blister	10	 5 903076 913531
80242	9-10/XL	blister	10	 5 903076 913548
80243	10-11/XXL	blister	10	 5 903076 913555







**■ Rękawice IDOL Perfect Garden**

- Wytrzymała i gruba pianka lateksowa
- Struktura poprawiająca chwyt
- Tkanina nylon + spandex – idealne dopasowanie do dłoni

index	rozmiar	opak.		EAN
80215	6/XS	blister	12/120	 5 903076 911643
80216	7/S	blister	12/120	 5 903076 911650
80217	8/M	blister	12/120	 5 903076 911667





**■ Rękawice IDOL White Garden**

- Wytrzymała powłoka poliuretanowa
- Cienka rękawica o dużej precyzji
- Tkanina poliestrowa

index	rozmiar	opak.		EAN
80221	6/XS	blister	12/240	 5 903076 913289
80222	7/S	blister	12/240	 5 903076 913296
80223	8/M	blister	12/240	 5 903076 913302

**■ Rękawice IDOL Green Garden**

- Wytrzymała powłoka nitrylowa
- Precyzyjny chwyt
- Tkanina poliestrowa

index	rozmiar	opak.		EAN
80218	6/XS	blister	12/240	 5 903076 913258
80219	7/S	blister	12/240	 5 903076 913265
80220	8/M	blister	12/240	 5 903076 913272

# KOMBINEZONY OCHRONNE I POLARY





## ■ Kombinezon ochronny Basic

- Lekki i wygodny
- Chroni przed pyłem i drobnymi zachlapaniami
- Elastyczne mankiety i kaptur
- Łatwe zakładanie - praktyczny suwak

index	rozmiar		EAN
81001	L	25	5 903076 910011
81002	XL	25	5 903076 910028
81003	XXL	25	5 903076 910035
81004	XXXL	25	5 903076 910042



Cat. I



## ■ Kombinezon ochronny Flex

- Idealny do dociepleń i prac izolacyjnych
- Oddychający - komfort nawet przy długiej pracy
- Elastyczny i wygodny - dopasowuje się do ruchów
- Łatwe zakładanie - praktyczny suwak

index	rozmiar		EAN
81006	L	50	5 903076 910066
81007	XL	50	5 903076 910073
81008	XXL	50	5 903076 910080
81009	XXXL	50	5 903076 910097



Cat. II  
0624

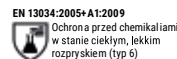

Ochrona przed chemikaliami w stanie ciekłym, lekkim rozpryskiem (typ 6)

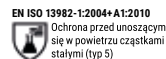

Ochrona przed unoszącymi się w powietrzu cząstkami stałymi (typ 5)



Ładunki elektrostatyczne

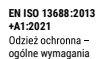

Odzież ochronna - ogólne wymagania



## ■ Kombinezon malarski Paint Pro

- Odporny na zachlapania - idealny do malowania i lakierowania
- Wytrzymały
- Elastyczne mankiety i kaptur
- Łatwe zakładanie - praktyczny suwak

index	rozmiar		EAN
81011	L	50	5 903076 910110
81012	XL	50	5 903076 910127
81013	XXL	50	5 903076 910134
81014	XXXL	50	5 903076 910141



Cat. III  
0624

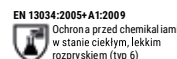

Ochrona przed chemikaliami w stanie ciekłym, lekkim rozpryskiem (typ 6)

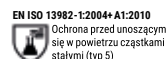

Ochrona przed unoszącymi się w powietrzu cząstkami stałymi (typ 5)



Ochrona przed chemikaliami

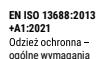

Odzież ochronna - ogólne wymagania

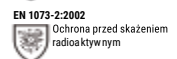

Ochrona przed skażeniem radioaktywnym

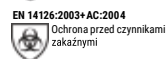

Ochrona przed czynnikami zakaźnymi



Ładunki elektrostatyczne

### ■ Maska przeciwpyłowa z zaworkiem (3 szt.)







 KLASA  
 FFP1

index		EAN
5707	100	 5 906554 511762



### ■ Polar Professional







- Gramatura materiału: 280 g
- Wzmocnienia (łaty) na łokciach
- Regulowane mankiety na rzep

index	rozmiar		EAN
9404	S	10	 5 903076 906434
9405	M	10	 5 903076 906441
9406	L	10	 5 903076 906458
9407	XL	10	 5 903076 906465
9408	XXL	10	 5 903076 906472



### ■ Polar Standard

- Lekki i wygodny
- Gramatura materiału: 280 g

index	rozmiar		EAN
9399	S	10	 5 903076 906427
9400	M	10	 5 903076 901996
9401	L	10	 5 903076 902009
9402	XL	10	 5 903076 902016
9403	XXL	10	 5 903076 902023



# MARKERY I OŁÓWKI



■ **Marker budowlany cienki**

- Wodoodporny, szybkoschnący
- Permanentny, precyzyjna końcówka
- Bardzo wydajny



index	końcówka		EAN
6687	precyzyjna 1,0 mm	12	 5 903076 908049

■ **Marker budowlany gruby**

- Wodoodporny, szybkoschnący
- Permanentny
- Bardzo wydajny



index	końcówka		EAN
6689	ścięta 1-5 mm	12	 5 903076 908063

### ■ Marker budowlany do otworów

- Wodoodporny, szybko schnący
- Cienka, długa końcówka

index	końcówka		EAN
6688	igłowa 0,6 mm	12	 5 903076 908056

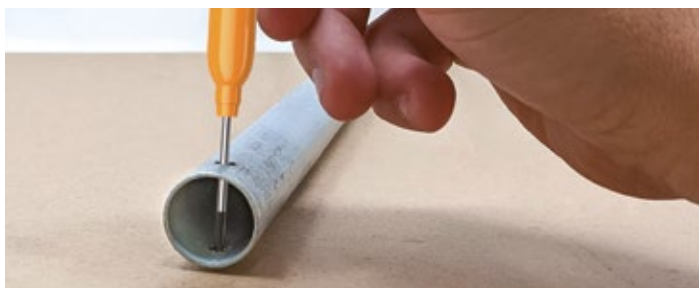

### ■ Marker permanentny cienki

- Bardzo intensywny, trwały tusz
- Na większość powierzchni
- Szybko schnący
- Precyzyjna cienka końcówka

index	końcówka	kolor		EAN
6690	okrągła 1,0 mm	 czarny	12	 5 903076 908070
6691	okrągła 1,0 mm	 niebieski	12	 5 903076 908087
6692	okrągła 1,0 mm	 czerwony	12	 5 903076 908094
6693	okrągła 1,0 mm	 zielony	12	 5 903076 908100



### ■ Marker permanentny gruby

- Bardzo intensywny, trwały tusz
- Na większość powierzchni
- Szybko schnący
- Gruba końcówka

index	końcówka	kolor		EAN
6694	okrągła 1,5 mm	 czarny	12	 5 903076 908117
6695	okrągła 1,5 mm	 niebieski	12	 5 903076 908124
6696	okrągła 1,5 mm	 czerwony	12	 5 903076 908308
6697	okrągła 1,5 mm	 zielony	12	 5 903076 908315





### ■ Marker olejny cienki

Marker olejowy z okrągłą fibrową końcówką o grubości 1,5 mm. Szybkoschnący i wodoodporny tusz olejny

index	kolor	📦	EAN
6671	● czarny	12	5 903076 907967
6672	○ biały	12	5 903076 907974
6673	● niebieski	12	5 903076 907981
6674	● czerwony	12	5 903076 907998
6675	● zielony	12	5 903076 908001
6676	● żółty	12	5 903076 908018



### ■ Marker olejny gruby

Marker olejowy z okrągłą fibrową końcówką o grubości 2,5 mm. Szybkoschnący i wodoodporny tusz olejny

index	kolor	📦	EAN
6677	● czarny	12	5 903076 908025
6678	○ biały	12	5 903076 908032





### ■ Marker dwustronny cienki

- Bardzo intensywny, trwały tusz
- Na większość powierzchni
- Szybkoschnący
- Dwie końcówki: igłowa 0,6 mm i okrągła 1,0 mm





index	kolor	📦	EAN
6698	● czarny	12	5 903076 911728

### ■ Ołówek automatyczny

index	zestaw		EAN
6684	ołówek + 6 wkładów	12	 5 903076 907288
6685	wkłady (3 kolory)	20	 5 903076 907295



### ■ Ołówek budowlany

index	twierdź	kolor		EAN
6680	HB	 zielony	50	 5 903076 907264
6681	6H	 czerwony	50	 5 903076 907271



### ■ Temperówka do ołówek budowlanych

index		EAN
6679	40	 5 903076 910158





# BLACK TIGER

## ORIGINAL

# WYTRZYMAŁE NOŻE I OSTRZA

## BLACK TIGER SERIES

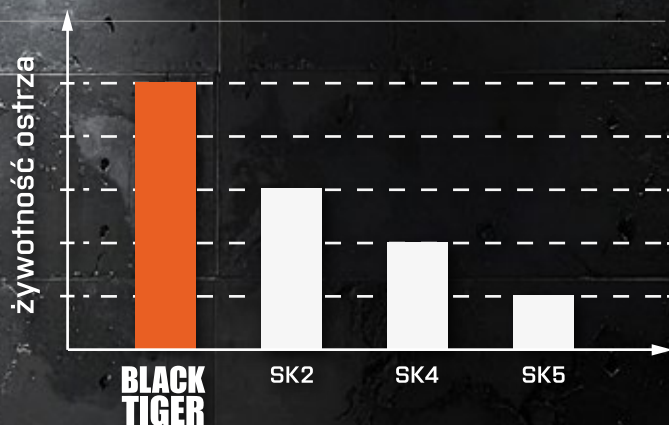

### Ostrza Black Tiger STANDARD

BLACK TIGER SERIES

index	szer. ostrza	grubość	opakowanie	☼	EAN
6476B	9 mm	0,4 mm	blister	10	5 903076 900395
5669	18 mm	0,5 mm	box	10	5 903076 909282
5669B	18 mm	0,5 mm	blister	10	5 903076 909305
6477B	25 mm	0,7 mm	blister	10	5 903076 900401

**40% GRUBSZE**



**0,7 mm**





### Ostrza Black Tiger 40% GRUBSZE

BLACK TIGER SERIES

index	szer. ostrza	grubość	opakowanie	☼	EAN
6475	18 mm	0,7 mm	box	10	5 903076 902979
6475B	18 mm	0,7 mm	blister	10	5 903076 900760

### ■ Ostrza Black Tiger ELASTYCZNE

BLACK TIGER SERIES

index	szer. ostrza	grubość	opakowanie		EAN
6474B	12,5 mm	0,2 mm	blister	12	 5 903076 900753



ELASTYCZNE OSTRZE





0,2 mm





### ■ Ostrza do noża trapezowego Black Tiger

BLACK TIGER SERIES

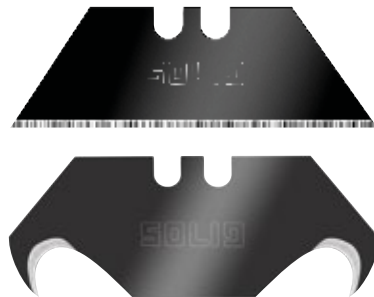
index	grubość	typ	opakowanie		EAN
6478B	0,5 mm	trapezowe	blister	10	 5 903076 900418
6479B	0,5 mm	hakowe	blister	10	 5 903076 900425





### ■ Ostrza do noża

index	szer. ostrza	typ		EAN
5930	18 mm	czarne, SK5	20	 5 903076 900203





### ■ Ostrza do noża

index	szer. ostrza	typ		EAN
5650	18 mm	standard, SK5	10	 5 906554 512721





**1+2 DODATKOWE OSTRZA**



**■ Nóż kompozytowy z 2 zapasowymi ostrzami**  
 BLACK TIGER SERIES

index	szer. ostrza	opakowanie		EAN
6487	18 mm	box	24	 5 903076 900883
6487B	18 mm	blister	10	 5 903076 900890



**■ Nóż kompozytowy płaski**  
 BLACK TIGER SERIES

index	szer. ostrza	opakowanie		EAN
6480	18 mm	box	24	 5 903076 900432
6480B	18 mm	blister	10	 5 903076 900449

**■ Nóż metalowy gumowany płaski**  
 BLACK TIGER SERIES





index	szer. ostrza	opakowanie		EAN
6482	18 mm	box	24	 5 903076 900729
6482B	18 mm	blister	12	 5 903076 900654

**■ Nóż metalowy gumowany**  
 BLACK TIGER SERIES

index	szer. ostrza	opakowanie		EAN
6481	18 mm	box	24	 5 903076 900722
6481B	18 mm	blister	12	 5 903076 900630

## ■ Nóż metalowy gumowany



### BLACK TIGER SERIES

index	szer. ostrza	opakowanie		EAN
5684	18 mm	box	24	 5 903076 909329
5684B	18 mm	blister	12	 5 903076 909343



## ■ Nóż metalowy



### BLACK TIGER SERIES

index	szer. ostrza	opakowanie		EAN
5639	18 mm	box	24	 5 906554 512967
5639B	18 mm	blister	12	 5 903076 909183



## ■ Nóż plastikowy gumowany



### BLACK TIGER SERIES

index	szer. ostrza	opakowanie		EAN
5642	18 mm	box	24	 5 906554 512320
5642B	18 mm	blister	12	 5 903076 909251



## ■ Nóż plastikowy

### BLACK TIGER SERIES

index	szer. ostrza	opakowanie		EAN
5641	18 mm	box	24	 5 906554 512714
5641B	18 mm	blister	12	 5 903076 909220



**■ Nóż plastikowy z metalowym ogonem**
**BLACK TIGER SERIES**

index	szer. ostrza	opakowanie		EAN
5683B	18 mm	blister	12	 5 903076 905123

**■ Nóż plastikowy gumowany**
**BLACK TIGER SERIES**

index	szer. ostrza	opakowanie		EAN
6484B	25 mm	blister	12	 5 903076 900682

**■ Nóż COLORS**

Ostrze SK5



index	szer. ostrza	kolor	opakowanie		EAN
5670	18 mm	   	box	24	 5 906554 518730

**■ Nóż metalowy**
**BLACK TIGER SERIES**

index	szer. ostrza	opakowanie		EAN
6483B	9 mm	blister	12	 5 903076 900685

■ **Nóż z elastycznym ostrzem**

BLACK TIGER SERIES

index	szer. ostrza	opakowanie		EAN
6486B	12,5 mm	blister	12	 5 903076 900777



ELASTYCZNE OSTRZE



0,2 mm



■ **Nóż metalowy gumowany trapezowy**

BLACK TIGER SERIES

index	opakowanie		EAN
6485B	blister	12	 5 903076 900708

1+2 DODATKOWE OSTRZA



■ **Nóż metalowy trapezowy**

BLACK TIGER SERIES

index	opakowanie		EAN
5685B	blister	12	 5 903076 909367

DOBIERZ PASUJĄCE OSTRZA



**Ostrza trapezowe  
Black Tiger**

index 6478B str. 31



**Ostrza hakowe  
Black Tiger**

index 6479B str. 31



■ **Nóż do wełny i styropianu**

index		EAN
6380	12	 5 906554 519386



■ Skrobak malarski BLACK TIGER



index		EAN
5636	10	 5 903076 910592

DOBIERZ PASUJĄCE OSTRZA



**Ostrza Black Tiger**  
index **5669** str. **30**



**Ostrza Black Tiger**  
**40% grubsze**  
index **6475** str. **30**

■ Piła do karton gipsu



index		EAN
5635	10	 5 903076 906984

■ Nóż do tapet



index	szer. ostrza	opakowanie		EAN
5640	18 mm	box	24	 5 906554 513032

■ Skrobak malarski



index		EAN
5638	10	 5 906554 513414



# MIARY

## ■ Miara zwijana Gold

Niezawodny mechanizm, gumowa antypoślizgowa obudowa

index	dł. / szer.	opakowanie	☐	EAN
6445	3 m / 16 mm	box	12	5 903076 907387
6445B	3 m / 16 mm	blister	12	5 903076 907394
6446	5 m / 19 mm	box	12	5 903076 900272
6446B	5 m / 19 mm	blister	12	5 903076 900289
6447	7,5 m / 25 mm	box	6	5 903076 907400
6447B	7,5 m / 25 mm	blister	6	5 903076 907417



## ■ Miara zwijana Master

Niezawodny mechanizm, 25% sztywniejsza taśma, gumowa antypoślizgowa obudowa

index	dł. / szer.	opakowanie	☐	EAN
6443	5 m / 25 mm	box	12	5 903076 900258
6443B	5 m / 25 mm	blister	12	5 903076 900265



## ■ Miara zwijana Magneto

Magnes neodymowy, podwójna blokada, niezawodny mechanizm

index	dł. / szer.	opakowanie	☐	EAN
6420	3 m / 19 mm	box	12	5 903076 909428
6420B	3 m / 19 mm	blister	12	5 903076 900081
6421	5 m / 25 mm	box	12	5 903076 909435
6421B	5 m / 25 mm	blister	12	5 903076 900098
6422	10 m / 25 mm	box	6	5 903076 909442
6422B	10 m / 25 mm	blister	6	5 903076 900104





### ■ Miara zwijana Glass

Gumowa końcówka zapobiega rysowaniu glazury i szkła, niezawodny mechanizm

index	dł. / szer.	opakowanie		EAN
6448	5 m / 19 mm	box	12	5 903076 900296
6448B	5 m / 19 mm	blister	12	5 903076 900302



### ■ Miara zwijana Auto-Hold

Gumowa antypoślizgowa obudowa, automatyczna blokada taśmy (hamulec odwrotny), niezawodny mechanizm

index	dł. / szer.	opakowanie		EAN
6423	3 m / 16 mm	box	12	5 903076 909459
6424	5 m / 25 mm	box	6	5 903076 909466



### ■ Miara zwijana Expert

Gumowa obudowa, niezawodny mechanizm, podwójna blokada

index	dł. / szer.	opakowanie		EAN
6439	3 m / 16 mm	box	12	5 903076 900234
6440	5 m / 19 mm	box	6	5 903076 900241



### ■ Miara zwijana Compact

Kompaktowy rozmiar, niezawodny wzmocniony mechanizm

index	dł. / szer.	opakowanie		EAN
5620	3 m / 16 mm	box	12	5 906554 518297
5621	5 m / 19 mm	box	12	5 906554 518303
5622	8 m / 25 mm	box	12	5 906554 518310



### ■ Miara drewniana składana

index	długość		EAN
6433	1 m	12	 5 903076 900661
6434	2 m	12	 5 903076 900678



### ■ Podpora teleskopowa



- maksymalne obciążenie przy 90 stopniach – 30 kg
- maksymalne obciążenie przy 65 stopniach – 15 kg
- gumowe oraz antypoślizgowe stopki
- system szybkiego rozsuwania

index	długość	nośność		EAN
6534	50 – 115 cm	30 kg	2	 5 903076 910578
6535	115 – 290 cm	30 kg	2	 5 903076 910585



### ■ Podpora teleskopowa

- maksymalne obciążenie przy 90 stopniach – 60 kg
- maksymalne obciążenie przy 65 stopniach – 20 kg
- gumowe oraz antypoślizgowe stopki
- system szybkiego rozsuwania

index	długość	nośność		EAN
6532	75 – 125 cm	60 kg	4	 5 903076 910554
6533	160 – 290 cm	60 kg	4	 5 903076 910561



# AKCESORIA MALARSKIE



## ■ Pędzel angielski Professional Series



index	rozmiar	☐	EAN
6565	1"	12	5 903076 909718
6566	1,5"	12	5 903076 909725
6567	2"	12	5 903076 909732
6568	2,5"	12	5 903076 909749
6569	3"	6	5 903076 909756

## ■ Pędzel angielski Elite



index	rozmiar	☐	EAN
6592	30 mm	6	5 903076 910165
6593	40 mm	6	5 903076 910172
6594	50 mm	6	5 903076 910189
6595	60 mm	6	5 903076 910196
6596	70 mm	6	5 903076 910202

■ Pełzel angielski Olejny

index	rozmiar	☒	EAN
6572	20 mm	24	5 903076 907325
6555	30 mm	12	5 906554 511328
6556	40 mm	12	5 906554 511915
6557	50 mm	12	5 906554 512363
6558	60 mm	12	5 906554 512394
6559	70 mm	12	5 906554 512707
6573	90 mm	12	5 903076 907332



■ Pełzel angielski Lazur

index	rozmiar	☒	EAN
6560	30 mm	12	5 906554 513025
6561	40 mm	12	5 906554 513629
6562	50 mm	12	5 906554 514664
6563	60 mm	12	5 906554 514695
6564	70 mm	12	5 906554 514701



■ Pełzel angielski Akryl

index	rozmiar	☒	EAN
6550	30 mm	12	5 906554 510079
6551	40 mm	12	5 906554 510086
6552	50 mm	12	5 906554 510116
6553	60 mm	12	5 906554 511236
6554	70 mm	12	5 906554 511243



■ Pełzel angielski Orange

index	rozmiar	☒	EAN
6700	1"	6	5 903076 907905
6701	1,5"	6	5 903076 907912
6702	2"	6	5 903076 907929
6703	2,5"	6	5 903076 907936
6704	3"	6	5 903076 907943
6705	4"	6	5 903076 907950



**■ Pędzel angielski Wood Expert**

index	rozmiar	☒	EAN
6730	1"	6	5 903076 911520
6731	1,5"	6	5 903076 911537
6732	2"	6	5 903076 911544
6733	2,5"	6	5 903076 911551
6734	3"	6	5 903076 911568
6735	4"	6	5 903076 911575

**■ Pędzel skośny Syntetyk**

index	rozmiar	☒	EAN
6588	1,5"	12	5 903076 907578
6589	2"	12	5 903076 907585
6590	2,5"	12	5 903076 907592
6591	3"	12	5 903076 907608

**■ Pędzel płaski Syntetyk**

index	rozmiar	☒	EAN
6582	1"	12	5 903076 907516
6583	1,5"	12	5 903076 907523
6584	2"	12	5 903076 907530
6585	2,5"	12	5 903076 907547
6586	3"	12	5 903076 907554
6587	4"	12	5 903076 907561

**■ Pędzel angielski uniwersalny**

index	rozmiar	☒	EAN
5204	1"	12	5 906554 510673
5205	1,5"	12	5 906554 510680
5206	2"	12	5 906554 510697
5207	2,5"	12	5 906554 510703
5208	3"	6	5 906554 510710
5209	3,5"	6	5 906554 510727
5210	4"	6	5 906554 510734

■ Pełdzel płaski uniwersalny

index	rozmiar	☐	EAN
5200	1"	12	5 906554 513056
5201	1,5"	12	5 906554 513063
5202	2"	12	5 906554 513070
5203	2,5"	12	5 906554 513087



■ Pełdzel kaloryferowy Professional Series

index	rozmiar	☐	EAN
6574	1,5" / 36 mm	6	5 903076 901156
6575	2" / 50 mm	6	5 903076 901163
6576	2,5" / 63 mm	6	5 903076 901170



■ Pełdzel kaloryferowy uniwersalny

index	rozmiar	☐	EAN
5211	1"	12	5 906554 510741
5212	1,5"	12	5 906554 510758
5213	2"	12	5 906554 510765
5214	2,5"	12	5 906554 510772



■ Pełdzel okrągły uniwersalny

index	rozmiar	☐	EAN
5215	20 mm	12	5 906554 510789
5216	25 mm	12	5 906554 510796
5217	30 mm	12	5 906554 510802
5218	35 mm	12	5 906554 510819
5219	40 mm	6	5 906554 510826
5220	45 mm	6	5 906554 510833
5221	50 mm	12	5 906554 510840
5222	55 mm	12	5 906554 510857
5223	60 mm	12	5 906554 510864
5224	70 mm	12	5 906554 510871











■ Pędzel tapetowy Professional Series

index	rozmiar		EAN
6570	120 mm	6	 5 903076 909763
6571	150 mm	6	 5 903076 909770



■ Pędzel tapetowy uniwersalny

index	rozmiar		EAN
5225	70 mm	10	 5 906554 510888
5226	90 mm	10	 5 906554 510895
5227	110 mm	10	 5 906554 510901
5228	130 mm	10	 5 906554 510918
5229	140 mm	10	 5 906554 510925
5230	150 mm	10	 5 906554 510932



■ Pędzel ławkowiec uniwersalny

index	rozmiar		EAN
5231	170 mm	12	 5 906554 510949
5232	180 mm	12	 5 906554 510956
5233	190 mm	12	 5 906554 510963



■ Pędzel Spalter



index	rozmiar		EAN
6736	80 mm	6	 5 903076 913616
6737	100 mm	6	 5 903076 913623
6738	120 mm	6	 5 903076 913630
6739	150 mm	6	 5 903076 913647

### ■ Pędzel nakrapiacz

index		EAN
5238	48	 5 906554 511014





### ■ Pędzel smołowiec rudy

index		EAN
5239	40	 5 906554 511021



### Trzonek bukowy do smołowca

index	rozmiar	średnica	typ		EAN
5782	150 cm	21 mm	gładki	25	 5 902891 286929

### ■ Pędzle malarskie 5 sztuk

index		EAN
6549	12	 5 903076 911995



### ■ Pędzle paskowe 4 sztuki

index	rozmiar		EAN
5726	6, 8, 10, 12 mm	12	 5 903076 912925



RĄCZKA MALARSKA

# Z KIJEM NA CLICK



**EUIPO**  
EUROPEAN UNION  
INTELLECTUAL PROPERTY OFFICE

REGISTERED DESIGN

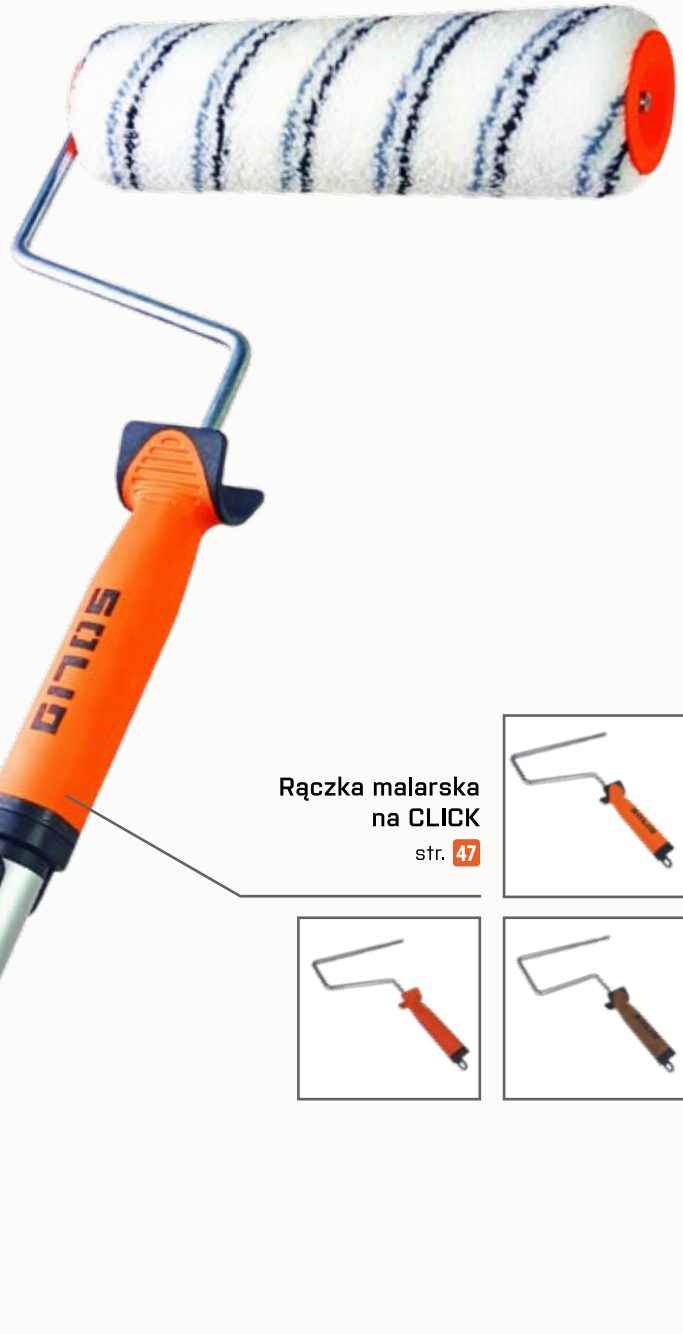

Niezawodne,  
wytrzymałe  
mocowanie na CLICK



Kij malarski  
na CLICK  
str. 47

Rączka malarska  
na CLICK  
str. 47



## BŁYSKAWICZNY MONTAŻ

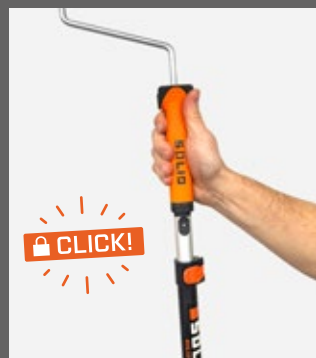
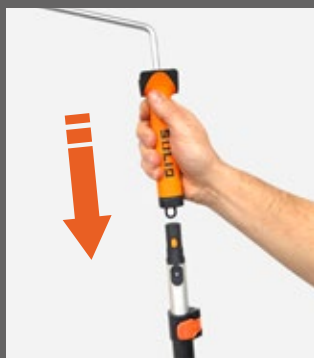

## ŁATWY DEMONTAŻ



■ Rączka malarska Premium



index	rozmiar	średnica	☐	EAN
6608	Maxi 18 cm	Ø 8 mm	10	5 903076 905215
6609	Maxi 25 cm	Ø 8 mm	10	5 903076 905222

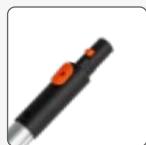

**DOBIERZ DO KOMPLETU**

**Kij malarski teleskopowy CLICK**

index **6597, 6598, 6599** str. 47



CLICK

■ Rączka malarska Premium Korek



index	rozmiar	średnica	☐	EAN
6610	Maxi 18 cm	Ø 8 mm	10	5 903076 905284
6611	Maxi 25 cm	Ø 8 mm	10	5 903076 905291



**DOBIERZ DO KOMPLETU**

**Kij malarski teleskopowy CLICK**

index **6597, 6598, 6599** str. 47



CLICK

■ Rączka malarska



index	rozmiar	średnica	☐	EAN
6600	Mini 6 cm	Ø 6 mm	10	5 903076 905130
6601	Średnia 10 cm	Ø 6 mm	10	5 903076 905147
6602	Długa 10 cm	Ø 6 mm	10	5 903076 905154
6603	Maxi 18 cm	Ø 8 mm	10	5 903076 905161
6604	Maxi 25 cm	Ø 8 mm	10	5 903076 905178



CLICK

■ Kij malarski teleskopowy CLICK



index	rozmiar	☐	EAN
6597	0,5 - 1,2 m	6	5 903076 905369
6598	1,0 - 1,8 m	6	5 903076 905376
6599	1,0 - 2,7 m	6	5 903076 905383



CLICK

**■ Rączka malarska 2K**

index	rozmiar	średnica		EAN
5290	Maxi 18 cm	Ø 8 mm	10	5 906554 519140
5291	Maxi 25 cm	Ø 8 mm	10	5 906554 519157
5297	Maxi 36 cm	Ø 8 mm	10	5 906554 511908
5298	Maxi 46 cm	Ø 8 mm	10	5 906554 513667

**■ Rączka malarska**

index	rozmiar	średnica		EAN
6627	Mini 6 cm	Ø 6 mm	10	5 903076 913340
6628	Średnia 10 cm	Ø 6 mm	10	5 903076 913357
6629	Długa 10 cm	Ø 6 mm	10	5 903076 913364
6630	Maxi 18 cm	Ø 8 mm	10	5 903076 913371
6631	Maxi 25 cm	Ø 8 mm	10	5 903076 913388
6632	Maxi 36 cm	Ø 8 mm	10	5 903076 913395
6633	Maxi 46 cm	Ø 8 mm	10	5 903076 913401

**■ Rączka malarska**

index	rozmiar	średnica		EAN
5300	Mini 6 cm	Ø 6 mm	70	5 906554 511854
5301	Średnia 10 cm	Ø 6 mm	25	5 906554 511861
5302	Długa 10 cm	Ø 6 mm	100	5 906554 511878
5299	Maxi 15 cm	Ø 6 mm	50	5 906554 513049
5303	Maxi 18 cm	Ø 8 mm	30	5 906554 511564
5304	Maxi 25 cm	Ø 8 mm	25	5 906554 511571

**■ Rączka malarska regulowana**

Do wałków malarskich o szerokości od 30 cm do 50 cm



index	rozmiar		EAN
6235	30 - 50 cm	30	5 903076 911254

### ■ Kij teleskopowy aluminiowy

index	rozmiar		EAN
6500	1 - 1,8 m	12	 5 903076 900838
6501	1,5 - 3 m	12	 5 903076 900845



### ■ Kij teleskopowy

index	rozmiar		EAN
5311	1 - 1,8 m	12	 5 906554 511830
5312	1,5 - 3 m	12	 5 906554 511847



### ■ Kij teleskopowy stalowy REDSHARK

Aluminiowy gwint; stalowa konstrukcja

index	rozmiar		EAN
6502	0,6 - 1,0 m	64	 5 903076 912756
6503	1,0 - 1,8 m	42	 5 903076 912763
6504	1,5 - 2,8 m	30	 5 903076 912770



### ■ Kij teleskopowy aluminiowy REDSHARK

Opatentowany gwint; aluminiowa konstrukcja

index	rozmiar		EAN
6505	0,6 - 1,2 m	36	 5 903076 912787
6506	1,0 - 1,8 m	25	 5 903076 912794





■ **Kuweta malarska 1 szt.  
+ wkładki wymienne 3 szt.**



index	rozmiar	wątek		EAN
6714	16 × 31 cm	11 cm	13	5 903076 903839
6715	27 × 41 cm	18 cm	8	5 903076 903846
6716	34 × 41 cm	25 cm	8	5 903076 903853



■ **Kuweta malarska SOLID**



index	rozmiar	wątek		EAN
5307	11 × 24 cm	8 cm	25	5 906554 511793
5308	16 × 31 cm	11 cm	20	5 906554 511809
5309	27 × 41 cm	18 cm	10	5 906554 511816
5310	34 × 41 cm	25 cm	10	5 906554 511823



**DOBIERZ DO KOMPLETU**

**Wkładki wymienne do kuwety**

index **6711, 6712, 6713** str. **50**





■ **Wkładki wymienne  
do kuwety SOLID**



index	rozmiar	wątek		EAN
6711	16 × 31 cm	11 cm	30	5 903076 903891
6712	27 × 41 cm	18 cm	30	5 903076 903907
6713	34 × 41 cm	25 cm	30	5 903076 903914

■ Kuweta malarska SOLID + wkład

index	rozmiar	wątek		EAN
6720	39 × 55 cm	46 cm	10	 5 903076 912725



■ Wkład do kuwety malarskiej SOLID

index	rozmiar	wątek		EAN
6721	39 × 55 cm	46 cm	10	 5 903076 912732



■ Kubek malarski + wkład

index	pojemność		EAN
6617	1.2 l	6	 5 903076 911889



■ Wkład do kubka malarskiego

index	pojemność		EAN
6618	1.2 l	12	 5 903076 911896



 **NAJLEPSZA CENA**



■ **Kuweta malarska ECO**

index	rozmiar	wątek		EAN
5293	24 × 35 cm	18 cm	10	 5 906554 512929
5294	32 × 36 cm	25 cm	10	 5 906554 512936





**DOBIERZ DO KOMPLETU**

**Wkłady wymienne do kuwety**

index **6711, 6712, 6713** str. **50**







■ **Wkłady wymienne do kuwety ECO**

index	rozmiar	wątek		EAN
5909	32 × 36 cm	25 cm	30	 5 903076 908971



■ **Kuweta malarska 1 szt.  
+ wkłady wymienne 3 szt.**

 **EU IPO**  
EUROPEAN UNION  
INTELLECTUAL PROPERTY OFFICE  
REGISTERED DESIGN

index	rozmiar	wątek		EAN
6717	16 × 31 cm	11 cm	13	 5 903076 903860
6718	27 × 41 cm	18 cm	8	 5 903076 903877
6719	34 × 41 cm	25 cm	8	 5 903076 903884



■ **Kuweta malarska SOLID**

 **EU IPO**  
EUROPEAN UNION  
INTELLECTUAL PROPERTY OFFICE  
REGISTERED DESIGN

index	rozmiar	wątek		EAN
5295	11 × 24 cm	8 cm	25	 5 906554 516057
5292	16 × 31 cm	11 cm	20	 5 906554 512912
6709	27 × 41 cm	18 cm	10	 5 903076 903792
6710	34 × 41 cm	25 cm	10	 5 903076 903808



**DOBIERZ DO KOMPLETU**

**Wkłady wymienne do kuwety**

index **6711, 6712, 6713** str. **50**

**■ Kratka malarska**

index	rozmiar		EAN
5315	22 / 26 cm	150	 5 906554 513506
5306	27 / 30 cm	100	 5 906554 511786



**■ Kratka malarska**

index	rozmiar		EAN
5318	22 / 26 cm	100	 5 906554 516699
5319	27 / 30 cm	100	 5 906554 516705



**■ Kratka malarska metalowa**

index	rozmiar		EAN
5314	26 / 30 cm	50	 5 906554 513315

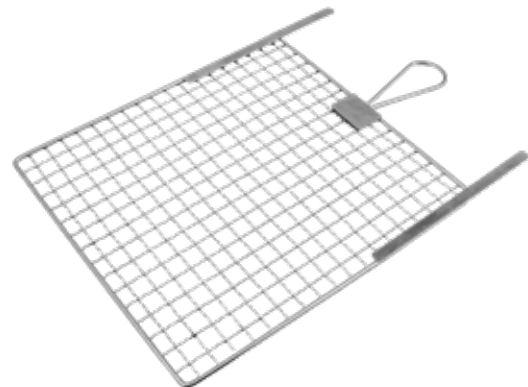

**■ Wiadro malarskie**

index	rozmiar		EAN
5316	8 l	20	 5 906554 513513
5313	12 l	20	 5 906554 511885



# WAŁKI I ZESTAWY MALARSKIE



## ■ Wałek malarski Black Silver

Tkanina: poliamid

Przeznaczenie: farby lateksowe, ceramiczne, akrylowe, emulsyjne



index	rozmiar	średnica	dł. włosia		EAN
<b>do gładkich powierzchni</b>					
5750	Mini 7 cm (2-pak)	Ø 16	10 mm	10	5 906554 518457
5751	Mini 10 cm (2-pak)	Ø 16	10 mm	10	5 906554 518464
5752	Mini 15 cm (2-pak)	Ø 16	10 mm	10	5 906554 518471
5753	Midi 10 cm	Ø 30	10 mm	10	5 906554 518488
5746	Midi 15 cm	Ø 30	10 mm	10	5 906554 519645
5761	Maxi 18 cm	Ø 48	10 mm	10	5 906554 518563
5762	Maxi 25 cm	Ø 48	10 mm	10	5 906554 518570
5763	Maxi 36 cm	Ø 48	10 mm	10	5 903076 912886
5749	Maxi 46 cm	Ø 48	10 mm	10	5 906554 518440

## ■ Wałek malarski Mikrofaza

Tkanina: mikrofaza

Przeznaczenie: farby emulsyjne, farby lateksowe, bejce, lakierobejce, podkłady gruntujące



index	rozmiar	średnica	dł. włosia		EAN
<b>do gładkich powierzchni</b>					
5744	Mini 6 cm (2-pak)	Ø 16	6 mm	10	5 906554 519911
5758	Mini 10 cm (2-pak)	Ø 16	6 mm	10	5 906554 518532
5759	Mini 15 cm (2-pak)	Ø 16	6 mm	10	5 906554 518549
5760	Midi 10 cm	Ø 30	10 mm	10	5 906554 518556
5745	Midi 15 cm	Ø 30	10 mm	10	5 906554 519638
5756	Maxi 18 cm	Ø 48	10 mm	10	5 906554 518518
5757	Maxi 25 cm	Ø 48	10 mm	10	5 906554 518525
5797	Maxi 36 cm	Ø 48	10 mm	10	5 903076 913715
5798	Maxi 46 cm	Ø 48	10 mm	10	5 903076 913722

### Walek malarski Assassin

Tkanina: poliakryl

Przeznaczenie: farby emulsyjne, akrylowe

index	rozmiar	średnica	dł. włosia		EAN
<b>do chropowatych powierzchni</b>					
5788	Mini 7 cm (2-pak)	Ø 16	10 mm	10	5 903076 912893
5789	Mini 10 cm (2-pak)	Ø 16	10 mm	10	5 903076 912909
5790	Mini 15 cm (2-pak)	Ø 16	10 mm	10	5 906554 519249
5791	Midi 10 cm	Ø 30	10 mm	10	5 906554 519256
5792	Midi 15 cm	Ø 30	10 mm	10	5 906554 519263
5793	Maxi 18 cm	Ø 48	12 mm	10	5 906554 519270
5794	Maxi 25 cm	Ø 48	12 mm	10	5 906554 519287
5795	Maxi 36 cm	Ø 48	12 mm	10	5 906554 519294
5796	Maxi 46 cm	Ø 48	12 mm	10	5 903076 912916



### Walek malarski Microlon

Tkanina: microlon

Przeznaczenie: farby lateksowe, ceramiczne, akrylowe, emulsyjne

index	rozmiar	średnica	dł. włosia		EAN
<b>do chropowatych powierzchni</b>					
6751	Mini 10 cm (2-pak)	Ø 16	14 mm	10	5 903076 913654
6752	Midi 10 cm	Ø 30	14 mm	10	5 903076 913661
6753	Maxi 18 cm	Ø 48	18 mm	10	5 903076 913678
6754	Maxi 25 cm	Ø 48	18 mm	10	5 903076 913685
6755	Maxi 36 cm	Ø 48	18 mm	10	5 903076 913692
6756	Maxi 46 cm	Ø 48	18 mm	10	5 903076 913708



### Walek malarski Mikrofaza Long

Tkanina: mikrofaza

Przeznaczenie: farby akrylowe, podkłady gruntujące, bejce (w wariantach wałków fasadowych również wszelkie farby elewacyjne/fasadowe)

index	rozmiar	średnica	dł. włosia		EAN
<b>do chropowatych powierzchni</b>					
5925	Mini 7 cm (2-pak)	Ø 16	10 mm	10	5 903076 912930
5926	Mini 10 cm (2-pak)	Ø 16	10 mm	10	5 903076 912947
5927	Mini 15 cm (2-pak)	Ø 16	10 mm	10	5 903076 912954
5928	Midi 10 cm	Ø 30	10 mm	10	5 903076 912961
5929	Midi 15 cm	Ø 30	10 mm	10	5 903076 912978
5754	Maxi 18 cm	Ø 48	15 mm	10	5 906554 518495
5755	Maxi 25 cm	Ø 48	15 mm	10	5 906554 518501
5747	Fasada 18 cm	Ø 68	15 mm	10	5 906554 519614
5748	Fasada 25 cm	Ø 68	15 mm	10	5 906554 519621



**Wałek malarski Syntex PRO**

Tkanina: poliamid

Przeznaczenie: farby emulsyjne, akrylowe (w wariacie wałków fasadowych również wszelkie farby elewacyjne/fasadowe)

index	rozmiar	średnica	dł. włosia		EAN
<b>do chropowatych powierzchni</b>					
5715	Maxi 18 cm	Ø 48	12 mm	10	5 906554 518587
5716	Maxi 25 cm	Ø 48	12 mm	10	5 906554 518594
5721	Maxi 18 cm	Ø 48	18 mm	10	5 906554 518624
5722	Maxi 25 cm	Ø 48	18 mm	10	5 906554 517627
5723	Fasada 18 cm	Ø 68	18 mm	10	5 906554 517634
5724	Fasada 25 cm	Ø 68	18 mm	10	5 906554 517641

**Wałek malarski Nylon PRO**

Tkanina: nylon poliamid

Przeznaczenie: lakiery rozpuszczalnikowe, lakiery akrylowe, farby olejne

index	rozmiar	średnica	dł. włosia		EAN
<b>do gładkich powierzchni</b>					
5142	Mini 10 cm (2-pak)	Ø 16	13 mm	10	5 906554 512943
5143	Midi 10 cm	Ø 16	13 mm	10	5 906554 512950
5140	Maxi 18 cm	Ø 48	13 mm	10	5 906554 515166
5141	Maxi 25 cm	Ø 48	13 mm	10	5 906554 515173

**Wałek malarski Żółta Nić**

Tkanina: poliakryl

Przeznaczenie: farby emulsyjne, farby lateksowe

index	rozmiar	średnica	dł. włosia		EAN
<b>do gładkich powierzchni</b>					
5193	Mini 7 cm (2-pak)	Ø 16	10 mm	10	5 906554 516200
5194	Mini 10 cm (2-pak)	Ø 16	10 mm	10	5 906554 516217
5195	Mini 15 cm (2-pak)	Ø 16	10 mm	10	5 906554 516224
5165	Midi 10 cm	Ø 30	10 mm	10	5 906554 511298
5166	Midi 15 cm	Ø 30	10 mm	10	5 906554 511304
5120	Maxi 18 cm	Ø 48	12 mm	10	5 906554 512639
5121	Maxi 25 cm	Ø 48	12 mm	10	5 906554 512646

### Walek malarski Bluestar

Tkanina: poliester

Przeznaczenie: farby akrylowe, lakiery akrylowe

index	rozmiar	średnica	dł. włosia		EAN
<b>do gładkich powierzchni</b>					
5106	Maxi 18 cm	Ø 48	8 mm	10	5 906554 510437
5107	Maxi 25 cm	Ø 48	8 mm	10	5 906554 510444



### Walek malarski Multicolor

Tkanina: poliakryl

Przeznaczenie: farby emulsyjne, akrylowe (w wariacie wałków fasadowych również wszelkie farby elewacyjne/fasadowe)

index	rozmiar	średnica	dł. włosia		EAN
<b>do chropowatych powierzchni</b>					
5159	Mini 7 cm (2-pak)	Ø 16	10 mm	10	5 906554 511038
5186	Mini 10 cm (2-pak)	Ø 16	10 mm	10	5 906554 515241
5187	Mini 15 cm (2-pak)	Ø 16	10 mm	10	5 906554 515258
5191	Midi 10 cm	Ø 30	10 mm	10	5 906554 516187
5192	Midi 15 cm	Ø 30	10 mm	10	5 906554 516194
5108	Maxi 18 cm	Ø 48	15 mm	10	5 906554 510413
5109	Maxi 25 cm	Ø 48	15 mm	10	5 906554 510420
5138	Fasada 18 cm	Ø 68	19 mm	10	5 906554 515142
5139	Fasada 25 cm	Ø 68	19 mm	10	5 906554 515159



### Walek malarski Nylon

Tkanina: nylon poliamid

Przeznaczenie: lakiery rozpuszczalnikowe, lakiery akrylowe, farby olejne









index	rozmiar	średnica	dł. włosia		EAN
<b>do gładkich powierzchni</b>					
5170	Mini 7 cm (2-pak)	Ø 16	6 mm	10	5 906554 511335
5180	Mini 10 cm (2-pak)	Ø 16	6 mm	10	5 906554 515180
5124	Maxi 18 cm	Ø 48	6 mm	10	5 906554 513254
5125	Maxi 25 cm	Ø 48	6 mm	10	5 906554 513261



**■ Wałek malarski Velur**

Tkanina: welur

Przeznaczenie: lakiery rozpuszczalnikowe, lakiery akrylowe, farby olejne

index	rozmiar	średnica	dł. włosia		EAN
<b>do gładkich powierzchni</b>					
5167	Mini 7 cm (2-pak)	Ø 16	5 mm	10	 5 906554 511311
5181	Mini 10 cm (2-pak)	Ø 16	5 mm	10	 5 906554 515197
5182	Mini 15 cm (2-pak)	Ø 16	5 mm	10	 5 906554 515203
5172	Midi 10 cm	Ø 30	5 mm	10	 5 906554 511717
5173	Midi 15 cm	Ø 30	5 mm	10	 5 906554 511724
5126	Maxi 18 cm	Ø 48	5 mm	10	 5 906554 513278
5127	Maxi 25 cm	Ø 48	5 mm	10	 5 906554 513285

**■ Wałek malarski Syntex**

Tkanina: poliakryl



Przeznaczenie: farby emulsyjne, akrylowe (w wariacie wałków fasadowych również wszelkie farby elewacyjne/fasadowe)

index	rozmiar	średnica	dł. włosia		EAN
<b>do chropowatych powierzchni</b>					
5102	Maxi 18 cm	Ø 48	18 mm	10	 5 906554 510390
5103	Maxi 25 cm	Ø 48	18 mm	10	 5 906554 510406
5104	Fasada 18 cm	Ø 68	18 mm	10	 5 906554 510475
5105	Fasada 25 cm	Ø 68	18 mm	10	 5 906554 510482

**■ Wałek malarski Czarny Pasek**

Tkanina: poliakryl





Przeznaczenie: farby lateksowe, akrylowe

index	rozmiar	średnica	dł. włosia		EAN
<b>do gładkich powierzchni</b>					
5122	Maxi 18 cm	Ø 48	12 mm	10	 5 906554 512899
5123	Maxi 25 cm	Ø 48	12 mm	10	 5 906554 512905

### Walek malarski Moltoflok

Tkanina: gąbka pokryta flokiem

Przeznaczenie: lakiery rozpuszczalnikowe, lakiery akrylowe, lakierobejce





index	rozmiar	średnica		EAN
5155	Mini 5 cm (2-pak)	Ø 16	10	 5 906554 510222
5183	Mini 7 cm (2-pak)	Ø 16	10	 5 906554 515210
5184	Mini 10 cm (2-pak)	Ø 16	10	 5 906554 515227
5185	Mini 15 cm (2-pak)	Ø 16	10	 5 906554 515234



### Walek malarski Moltopren

Tkanina: gąbka

Przeznaczenie: lakiery akrylowe, farby emulsyjne, bejce

index	rozmiar	średnica		EAN
5151	Mini 5 cm (2-pak)	Ø 16	10	 5 906554 510185
5152	Mini 7 cm (2-pak)	Ø 16	10	 5 906554 510192
5188	Mini 10 cm (2-pak)	Ø 16	10	 5 906554 515265
5189	Mini 15 cm (2-pak)	Ø 16	10	 5 906554 515272



### Walek malarski do odcięć

index	info		EAN
5241	komplet	10	 5 906554 517122



### Walek do tapet

index	rozmiar		EAN
5174	5 cm	10	 5 906554 511656
5175	15 cm	10	 5 906554 511663



### Walek do narożników

index		EAN
5179	10	 5 906554 511601



**Zestaw malarski SOLID**
**Zestaw zawiera:**

5762	Wałek Poliamid Premium Black Silver, Maxi 25 cm, 1 szt.	55
5304	Rączka Maxi Ø8 25 cm, 1 szt.	48
5206	Pędzel angielski uniwersalny 2", 1 szt.	42
5072	Folia LDPE Extra Mocna 4x5 m, 1 szt.	80
5146	Taśma malarska Soft UV 25 mm / 50 m, 1 szt.	65
6713	Wkład do kuwety na wał. 25 cm, 3 szt.	50
5310	Kuweta malarska SOLID na wał. 25 cm, 1 szt.	50

index	rozmiar		EAN
5161	25 cm	5	

**Zestaw malarski ECO**
**Zestaw zawiera:**

5121	Wałek Żółta Nić Maxi 25 cm, 1 szt.	56
5304	Rączka Maxi Ø8 25 cm, 1 szt.	48
5202	Pędzel angielski uniwersalny 2", 1 szt.	42
5071	Folia HDPE Ochronna 4x5 m, 1 szt.	81
5012	Taśma malarska Strong 25 mm / 50 m, 1 szt.	67
5294	Kuweta malarska ECO na wał. 25 cm, 1 szt.	52

index	rozmiar		EAN
5160	25 cm	5	

**Zestaw malarski MK25**
**Zestaw zawiera:**

5757	Wałek Mikrofaza maxi 25 cm, 1 szt.	55
5304	Rączka Maxi Ø8 25 cm, 1 szt.	48
5310	Kuweta malarska 31/35 cm, 1 szt.	50

index		EAN
5549	8	

**Zestaw malarski ZN25**
**Zestaw zawiera:**

5121	Wałek Żółta Nić maxi 25 cm, 1 szt.	56
5304	Rączka Maxi Ø8 25 cm, 1 szt.	48
5310	Kuweta malarska 34/41 cm, 1 szt.	50

index		EAN
5548	8	

### ■ Zestaw malarski MK10

**Zestaw zawiera:**

5758	Walek Mikrofaza mini 10 cm, 2 szt.	55
5301	Rączka mini, 1 szt.	48
5308	Kuweta malarska 14/30 cm, 1 szt.	61

index		EAN
5547	30	5 906554 514732



### ■ Zestaw malarski ZN10

**Zestaw zawiera:**

5194	Walek Żółta Nić Mini 10 cm, 2 szt.	56
5301	Rączka mini, 1 szt.	48
5308	Kuweta malarska 14/30 cm, 1 szt.	61

index		EAN
5546	30	5 906554 514725



### ■ Zestaw malarski Velur

**Zestaw zawiera:**

5181	Walek Velur mini 10 cm, 2 szt.	57
5205	Pędzel angielski uniwersalny 1,5", 1 szt.	42
5301	Rączka malarska 10 cm, 1 szt.,	48
5308	Kuweta malarska 16/31 cm, 1 szt.	62

index		EAN
5544	6	5 903076 913036



### ■ Zestaw malarski MP10

**Zestaw zawiera:**

5188	Walek Moltopren mini 10 cm, 2 szt.	58
5301	Rączka mini, 1 szt.	48
5308	Kuweta malarska 16/31 cm, 1 szt.	50

index		EAN
5177	6	5 906554 515029





**Zestaw malarski MP5**

Zestaw zawiera:

5151	Wałek Moltopren mini 5 cm, 2 szt.	58
5300	Rączka mini, 1 szt.	48
5307	Kuweta malarska 12/19 cm, 1 szt.	50

index		EAN
5176	50	5 906554 515012

**CLICK**



**Wałek malarski Black Silver + rączka CLICK**

Dedykowany do farb ceramicznych

index	rozmiar	średnica	dł. włosia		EAN
do gładkich powierzchni					
6613	18 cm zestaw	Ø 48	10 mm	10	5 903076 905888
6614	25 cm zestaw	Ø 48	10 mm	10	5 903076 905895

**Wałek malarski ZN10 + rączka**

Zestaw zawiera:

5194	Wałek Żółta Nić Mini 10 cm, 2 szt.	56
5301	Rączka mini, 1 szt.	48



index		EAN
5148	50	5 906554 518068

# TAŚMA ELEWACYJNA PROFESSIONAL SERIES

INNOWACYJNA  
FORMUŁA KLEJU

No. 1



Łatwe  
przerywanie



Odporna  
na warunki  
atmosferyczne



Nie pozostawia  
kleju



Wysoka przyczepność  
do wszystkich  
powierzchni

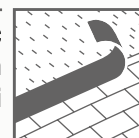

PROFESSIONAL SERIES

## ■ Taśma elewacyjna Professional Series

Idealna do prac tynkarskich i budowlanych

index	rozmiar	☐	EAN
5709	10 mm / 50 m	120	5 906554 511113
5713	25 mm / 50 m	48	5 903076 908889
5712	38 mm / 50 m	32	5 906554 519676
5710	48 mm / 50 m	24	5 906554 517832



## PROFESSIONAL SERIES



INNOWACYJNA  
FORMUŁA  
KLEJU



## ■ Taśma elewacyjna

Idealna do prac tynkarskich i budowlanych

index	rozmiar	☐	EAN
5619	38 mm / 33 m	30	5 906554 517849
5090	48 mm / 33 m	36	5 906554 510123
5674	38 mm / 50 yd (46m)	32	5 902891 286707
5675	48 mm / 50 yd (46m)	24	5 902891 286714



## SOLID STANDARD





**■ Taśma elewacyjna**

Idealna do prac tynkarskich i budowlanych

index	rozmiar		EAN
5892	48 mm / 50 m	24	 5 903076 901255



**ŁATWE PRZERYWANIE**



**■ Taśma zabezpieczająca SPEC**

Wodoodporna taśma do zabezpieczania; do zewnętrznego oraz wewnętrznego użytku

index	rozmiar		EAN
5853	38 mm / 50 m	32	 5 903076 903051
5839	48 mm / 50 m	24	 5 906554 516330



**■ Taśma PVC pomarańczowa**

Wodoodporna taśma do zabezpieczania

index	rozmiar		EAN
5676	38 mm / 50 m	32	 5 903076 903068
5628	48 mm / 50 m	24	 5 906554 519393



**★ NAJLEPSZA CENA**



**■ Taśma tynkarska**

- Do odcięć na powierzchniach tynkowanych
- Do chropowatych podłoży

index	rozmiar		EAN
9125	38 mm / 50 yd (46m)	28	 5 903076 908926
9126	48 mm / 50 yd (46m)	24	 5 903076 908933

**PRZEMYSŁANE**

**ROZWIĄZANIA**

**TAŚMA  
SOFT UV**

**TAŚMA  
STRONG UV**

**DELIKATNY KLEJ**

**MOCNY KLEJ**

**ZASTOSOWANIE**

Do szybkiego użycia,  
zaraz po pierwszym  
malowaniu

**ZASTOSOWANIE**

Do zabezpieczenia  
stolarki okiennej  
i drzwiowej



**■ Taśma malarska SOFT UV**

index	rozmiar	☐	EAN
5146	25 mm / 50 m	36	5 906554 519492
5067	30 mm / 50 m	40	5 906554 512035
5068	38 mm / 50 m	24	5 906554 513605
5069	48 mm / 50 m	24	5 906554 513612



**DELIKATNY KLEJ**



**■ Taśma malarska STRONG UV**

index	rozmiar	☐	EAN
5831	25 mm / 50 m	24	5 906554 515470
5832	30 mm / 50 m	24	5 906554 515487
5833	38 mm / 50 m	24	5 906554 515494
5834	48 mm / 50 m	24	5 906554 515500



**MOCNY KLEJ**



**Nr 1 JAPAN**  
TECHNOLOGY

**WASHI  
TAPE**



■ Taśma malarska Washi SAMURAJ

Nie podcieka, czyste i ostre krawędzie; wysoka przyczepność; wodoodporna

index	rozmiar	📦	EAN
5840	12 mm / 50 m	40	5 903076 900562
5819	19 mm / 50 m	32	5 903076 906410
5835	25 mm / 50 m	36	5 906554 516286
5836	30 mm / 50 m	32	5 906554 515418
5837	38 mm / 50 m	24	5 906554 515425
5838	48 mm / 50 m	24	5 906554 515432



**WASHI  
TAPE**



■ Taśma malarska Washi Delikatna

Delikatny klej typu LOW TACK, nie podcieka, czyste i ostre krawędzie, do delikatnych i gładkich powierzchni

index	rozmiar	📦	EAN
5550	25 mm / 50 m	36	5 906554 519188
5551	35 mm / 50 m	32	5 906554 519195
5552	45 mm / 50 m	24	5 906554 519201



**WASHI  
TAPE**



■ Taśma malarska Washi Lakiernicza







Wysoka przyczepność, odporność termiczna do 100°C; idealna do prac lakierniczych

index	rozmiar	📦	EAN
5980	30 mm / 50 m	32	5 903076 913777
5981	38 mm / 50 m	24	5 903076 913784
5982	48 mm / 50 m	24	5 903076 913791



**■ Taśma malarska 7 DAYS**





Do zabezpieczania i do odcięć malarskich; do prac malarskich i lakierniczych

index	rozmiar		EAN
5843	19 mm / 50 m	48	 5 903076 909657
5844	25 mm / 50 m	24	 5 903076 909664
5845	30 mm / 50 m	24	 5 903076 909671
5846	38 mm / 50 m	24	 5 903076 909688
5847	48 mm / 50 m	24	 5 903076 909695



**■ Taśma malarska niebieska Economy**







- Do zastosowania wewnątrz pomieszczeń
- Odporna na promieniowanie UV do 14 dni

index	rozmiar		EAN
5849	30 mm / 50 yd (46m)	40	 5 906554 519577
5850	38 mm / 50 yd (46m)	24	 5 906554 519584
5851	48 mm / 50 yd (46m)	24	 5 906554 519591



**■ Taśma malarska żółta Economy**

- Do zastosowania wewnątrz pomieszczeń
- Odporna na promieniowanie UV do 14 dni

index	rozmiar		EAN
5011	19 mm / 50 m	48	 5 906554 511465
5012	25 mm / 50 m	36	 5 906554 511472
5013	30 mm / 50 m	40	 5 906554 511489
5014	38 mm / 50 m	24	 5 906554 511496
5015	48 mm / 50 m	24	 5 906554 511502



**Folia z taśmą niebieską STRONG UV**

Taśma klejąca i folia w jednym; zapewnia szybkie i dokładne maskowanie powierzchni; grubość folii 10 my

index	rozmiar		EAN
5730	55 cm / 20 m	60	5 902891 286523
5731	140 cm / 20 m	30	5 902891 286530
5733	210 cm / 20 m	25	5 906554 516910
5732	270 cm / 15 m	30	5 902891 286547

**Folia z taśmą elewacyjną 30 mm**

Folia z taśmą tkaninową, wysoka przyczepność do wszystkich powierzchni, wodoodporna

index	rozmiar		EAN
5738	55 cm / 15 m	24	5 903076 906366
5739	140 cm / 15 m	24	5 906554 519003
5740	210 cm / 15 m	24	5 906554 512745

**WASHI  
TAPE**

**Folia z taśmą zieloną lakierniczą**

Nie podcieka, czyste i ostre krawędzie; wysoka przyczepność; wodoodporna

index	rozmiar		EAN
5595	55 cm / 20 m	40	5 903076 913739
5596	140 cm / 20 m	30	5 903076 913746
5597	210 cm / 20 m	25	5 903076 913753
5598	270 cm / 15 m	25	5 903076 913760



■ Folia z taśmą WASHI

Nie podcieka, czyste i ostre krawędzie; wysoka przyczepność; wodoodporna

**Nr 1 JAPAN**  
TECHNOLOGY

**WASHI  
TAPE**



index	rozmiar	☐	EAN
5734	55 cm / 20 m	40	5 906554 517856
5735	140 cm / 20 m	30	5 906554 517863
5736	210 cm / 20 m	25	5 906554 517870
5737	270 cm / 15 m	25	5 903076 905116



■ Dyspenser do folii z taśmą

index	rozmiar	☐	EAN
5728	55 cm / 20 m	30	5 903076 901675
5729	270 cm / 15 m	25	5 906554 516903



■ Taśma ślizgowa

index	rozmiar	☐	EAN
9128	48 mm / 50 m	36	5 903076 900852



# TAŚMA DWUSTRONNA MAXI STRONG

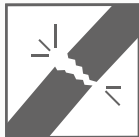

Łatwe  
przerwanie



Ultra mocny klej

Wzmocniona  
tkaniną

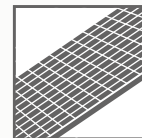

Wysoka przyczepność  
do wszystkich  
powierzchni



## PROFESSIONAL SERIES



### ■ Taśma dwustronna wzmocniona MAXI STRONG Professional Series

Idealna do wykładzin, folii budowlanych i ogrodniczych, do profili oraz prac dekarских

index	rozmiar	📦	EAN
5100	48 mm / 25 m	36	5 906554 514558



## SOLID STANDARD



### ■ Taśma dwustronna wzmocniona

Idealna do wykładzin, folii budowlanych i ogrodniczych, do profili oraz prac dekarских

index	rozmiar	📦	EAN
5053	48 mm / 10 m	36	5 906554 511267
5054	48 mm / 25 m	36	5 906554 511274



### ■ Taśma dwustronna Economy

- Do łączenia folii i podklejania wykładzin
- Odpowiednia do gładkich powierzchni

index	rozmiar		EAN
5056	48 mm / 10 m	36	 5 906554 510635
5057	48 mm / 25 m	36	 5 906554 510321



### ■ Taśma piankowa

Do szybkiego montażu wieszaków, listew, w gospodarstwie domowym i automotive

index	rozmiar		EAN
5042	19 mm / 5 m	96	 5 906554 510659
5043	25 mm / 5 m	72	 5 906554 510642



### ■ Taśma do folii transparentna

Do sklejania folii dachowych, ogrodowych i budowlanych; wysoka przyczepność; wodoodporna

index	rozmiar		EAN
5040	48 mm / 50 m	24	 5 906554 511137



### ■ Taśma aluminiowa

Do stosowania w pracach przy systemach grzewczych i klimatyzacyjnych

index	rozmiar		EAN
5101	48 mm / 50 yd (46 m)	24	 5 906554 511120



# TAŚMA SUPER DUCT



Mocny,  
pewny klej



Łatwe  
przerywanie



Wysoka przyczepność  
do wszystkich  
powierzchni



Odporna  
na warunki  
atmosferyczne



## PROFESSIONAL SERIES



### ■ Taśma SUPER DUCT Professional Series

Wysoka przyczepność do stali, tworzyw i kamienia; do prac hydraulicznych, naprawczych i lekkich prac budowlanych

index	rozmiar		EAN
5093	48 mm / 50 yd (46 m)	24	5 906554 513544



## SOLID STANDARD



### ■ Taśma Duct





Wysoka przyczepność do stali, tworzyw i kamienia; do prac hydraulicznych, naprawczych i lekkich prac budowlanych

index	rozmiar		EAN
5024	48 mm / 25 yd (23 m)	36	5 906554 511533
5025	48 mm / 50 yd (46 m)	24	5 906554 511540



### ■ Taśma flizelinowa









Do połączeń płyt kartonowo-gipsowych; zabezpiecza przed pęknięciami

index	rozmiar		EAN
5036	50 mm / 25 m	100	 5 906554 511144
5556	100 mm / 25 m	50	 5 903076 905925
5557	150 mm / 25 m	50	 5 906554 519553
5085	1000 mm / 25 m	4	 5 906554 512868



### ■ Taśma łączeniowa KARTON-GIPS

Do połączeń płyt kartonowo-gipsowych; zabezpiecza przed pęknięciami

index	rozmiar		EAN
5060	45 mm / 20 m	84	 5 906554 512554
5061	45 mm / 45 m	56	 5 906554 512561
5062	45 mm / 90 m	42	 5 906554 512578
5063	45 mm / 150 m	24	 5 906554 512585
5031	100 mm / 20 m	24	 5 906554 510666
5032	150 mm / 20 m	25	 5 906554 510604
5720	200 mm / 20 m	12	 5 906554 517580



### ■ Taśma papierowa na łączenia

Do połączeń płyt kartonowo-gipsowych; zabezpiecza przed pęknięciami

index	rozmiar		EAN
5708	50 mm / 75 m	24	 5 906554 516170



### ■ Taśma z wkładką aluminiową

Do wyrównywania i wzmacniania narożników, utrwala ich powierzchnię i zapobiega uszkodzeniom

index	rozmiar		EAN
5039	50 mm / 30 m	10	 5 906554 512820



**■ Taśma akustyczna**

Poprawia izolację akustyczną konstrukcji z płyt K-G; zapobiega przenoszeniu się drgań na powierzchnię ścian

index	rozmiar		EAN
5066	30 mm / 30 m	30	5 906554 513599
5033	48 mm / 30 m	10	5 906554 511984
5034	75 mm / 30 m	12	5 906554 511991
5035	95 mm / 30 m	10	5 906554 512004

**■ Taśma silikonowa do wanien**

Wodoodporna, odporna na pleśń

index	rozmiar		EAN
5044	22 mm / 3,35 m	40	5 906554 510352
5045	38 mm / 3,35 m	20	5 906554 510369

**■ Taśma elektroizolacyjna**

Przeznaczone do prac elektrycznych

index	rozmiar	kolor		EAN
5046	15 mm / 10 m	czarny	100	5 906554 515609
5047	15 mm / 10 m	multikolor	100	5 906554 515616
5048	19 mm / 10 m	czarny	96	5 906554 515623
5049	19 mm / 10 m	multikolor	96	5 906554 515630

**■ Taśma pakowa**

Do zaklejania kartonów

index	rozmiar	kolor		EAN
5711	48 mm / 66 m	transparentny	36	5 906554 517382
5099	48 mm / 66 m	brązowy	36	5 906554 516163

### ■ Taśma pakowa



Do zabezpieczania ciężkich paczek, zaklejania kartonów

index	rozmiar	kolor		EAN
5037	50 mm / 35 m	brązowy	36	 5 906554 510338
5038	50 mm / 35 m	transparentny	36	 5 906554 510345



### ■ Taśma ostrzegawcza

Wytrzymała taśma ostrzegawcza do zabezpieczania terenów budowy itp.

index	rozmiar		EAN
5051	80 mm / 100 m (Premium)	30	 5 906554 510178
9127	75 mm / 100 m	24	 5 903076 909817



# WORKI NA ODPADY



## Worki Maxi Pack

index	pojemność	szt. w rolce		EAN
5880	60 l	20	20	5 906554 515296
5860	120 l	20	11	5 906554 513438
5861	160 l	10	19	5 906554 513445
5862	240 l	10	8	5 906554 513452

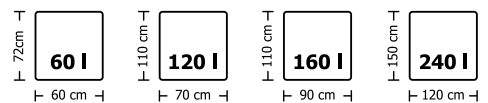

**Worki na gruz**

index	pojemność	szt. w rolce		EAN
5082	120 l	10	9	5 906554 510130

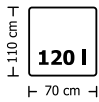

**Worki budowlane**

index	pojemność	szt. w rolce		EAN
5080	240 l	10	6	5 906554 515692

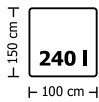

**Worki na styropian**

index	pojemność	szt. w rolce		EAN
21141	300 l	10	6	5 903076 907301
21142	400 l	8	6	5 903076 901262

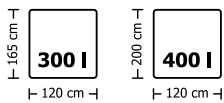

**Worki Mega Pack LDPE**

index	pojemność	szt. w rolce		EAN
5919	60 l	20	10	5 903076 901385
5920	120 l	20	11	5 903076 901392
5921	160 l	10	19	5 903076 901408
5922	240 l	10	8	5 903076 901415
5923	300 l	10	6	5 903076 901422
5924	400 l	8	6	5 903076 901439

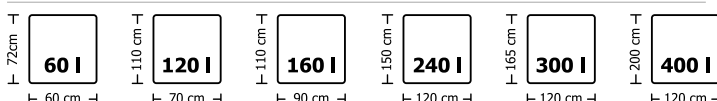

Worki na recykling



index	pojemność	szt. w rolce	kolor		EAN
5886	120 l	10	żółty	10	5 906554 515302
5887	120 l	10	niebieski	10	5 906554 515319
5888	120 l	10	zielony	10	5 906554 517696
5889	120 l	10	brązowy	10	5 906554 517702
5878	160 l	10	brązowe	14	5 903076 911865
5876	160 l	10	żółte	14	5 903076 911841
5879	240 l	10	brązowe	8	5 903076 911872
5877	240 l	10	żółte	8	5 903076 911858

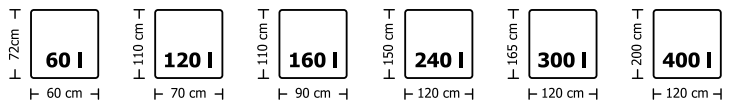

Worki Silver Pack LDPE z taśmą



index	pojemność	szt. w rolce		EAN
5864	60 l	15	10	5 906554 513476

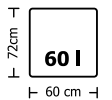

Worki Super Pack LDPE





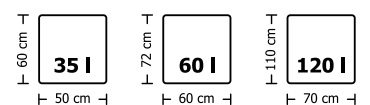

index	pojemność	szt. w rolce		EAN
5077	35 l	30	10	5 906554 515661
5078	60 l	20	10	5 906554 515678
5079	120 l	10	10	5 906554 515708



# FOLIE OCHRONNE



■ Folia tynkarska TRANSPARENT LDPE

index	nazwa	wymiary	waga		EAN	opakowanie
5095	SOFT	20 m <sup>2</sup> (4 × 5 m)	450 g	35	5 906554 513568	
5094	HARD	20 m <sup>2</sup> (4 × 5 m)	700 g	22	5 906554 513551	
5961	MEGA	20 m <sup>2</sup> (4 × 5 m)	1000 g	12	5 906554 519799	
5962	MAXI	20 m <sup>2</sup> (4 × 5 m)	1500 g	10	5 906554 519805	



■ Folia TYNKARSKA LDPE

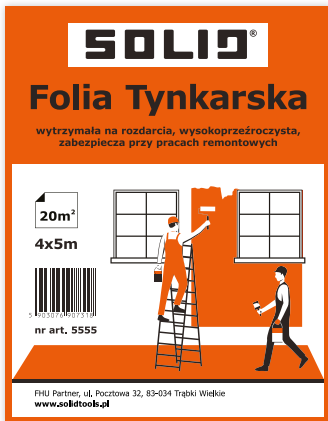

index	wymiary		EAN
5555	4 × 5 m = 20 m <sup>2</sup>	32	5 903076 907318

**BUDOWLANA**



CHRONI PRZED FARBA, KURZEM I BRUDEM

PL - Folia malarska  
EN - Plastic drop cloth  
RU - Пластиковая пленка  
DE - Malerplane  
CZ - Malářská fólie  
SK - Malárska fólia  
RO - Folie de protecție  
HU - Takarófolia  
UA - Фольга малярська  
SI - Zaščitna folija  
LT - Plėvelė uždengimui  
LV - Mākoņlīnne  
EE - Kaitekile  
BG - Пластмасов настил  
HR - Zaštitna folija  
SR - Zaštitna folija  
NL - Schilderfolie  
EW - Schilderfolie

20m<sup>2</sup>  
4m  
5m



LDPE index 5075

■ Folia malarska SŁOMKA LDPE



WYPRODUKOWANO  
**100%**  
Z RECYKLINGU

index	nazwa	wymiary	waga		EAN	opakowanie
5072	EXTRA MOCNA	20 m <sup>2</sup> (4 × 5 m)	250 g	45	5 902891 286011	
5073	STRONG	20 m <sup>2</sup> (4 × 5 m)	450 g	25	5 906554 511397	
5074	SUPER GRUBA	20 m <sup>2</sup> (4 × 5 m)	700 g	20	5 902891 286035	
5075	BUDOWLANA	20 m <sup>2</sup> (4 × 5 m)	1000 g	12	5 902891 286202	
5958	PLANDEKA	20 m <sup>2</sup> (4 × 5 m)	1500 g	10	5 906554 519768	



**Folia malarska CZARNA LDPE**



index	nazwa	wymiary	waga		EAN	opakowanie
5086	EXTRA ECO	20 m <sup>2</sup> (4 × 5 m)	250 g	35	5 906554 517337	
5097	STRONG ECO	20 m <sup>2</sup> (4 × 5 m)	450 g	30	5 906554 513643	
5098	SUPER ECO	20 m <sup>2</sup> (4 × 5 m)	700 g	22	5 906554 513650	
5956	MEGA ECO	20 m <sup>2</sup> (4 × 5 m)	1000 g	12	5 906554 519744	
5870	MAXI ECO	20 m <sup>2</sup> (4 × 5 m)	1500 g	10	5 906554 517528	





**Folia OCHRONNA HDPE**

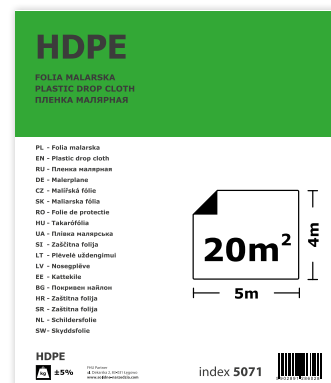

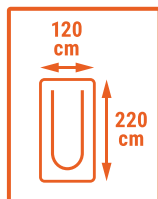
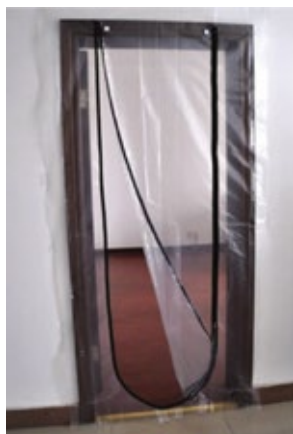
index	wymiary	waga		EAN
5071	4 × 5 m = 20 m <sup>2</sup>	60 g	40	5 902891 286028



**U-TYPE**
**■ Kurtyna drzwiowa z zamkiem**

index	wymiary	wariant		EAN
6279	120 × 220 cm	z taśmą dwustronną 25 mm / 7 m	10	 5 903076 905932
6280	120 × 220 cm	brak	10	 5 906554 519966

**■ Rynna tymczasowa foliowa**

index	średnica	długość		EAN
6200	Ø 75 – 125 mm	20 m	15	 5 903076 907509







**■ Folia na rolce TRANSPARENT**

index	wymiary		EAN
5872	2 m / 50 m	1	 5 906554 517542

**■ Folia na rolce SŁOMKA**

index	wymiary		EAN
5871	2 m / 50 m	1	 5 906554 517535

■ Folia samoprzylepna niebieska

index	wymiary		EAN
9989	300 mm / 50 m	6	 5 903076 913326
9990	500 mm / 30 m	6	 5 906554 519409
9991	500 mm / 50 m	6	 5 903076 908964
9992	500 mm / 75 m	6	 5 903076 901651
9993	500 mm / 100 m	6	 5 903076 901668





■ Folia samoprzylepna na okna transparentna

index	wymiary		EAN
5891	500 mm / 50 m	6	 5 906554 512370
5890	500 mm / 75 m	6	 5 903076 913319





■ Folia stretch

index	wymiary	kolor		EAN
5091	500 mm / 1,3 kg	transparent	6	 5 906554 515677
5076	500 mm / 2,3 kg	transparent	6	 5 906554 512011
5092	500 mm / 1,3 kg	czarny	6	 5 906554 515654



■ Mata malarska

Podbita wodoodporną folią

index	rozmiar	gramatura		EAN
5894	1 m × 10 m	220 g/m <sup>2</sup>	6	 5 903076 904874
5895	1 m × 25 m	220 g/m <sup>2</sup>	6	 5 903076 907257

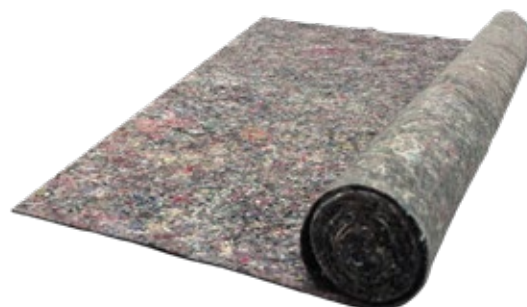















**■ Worek polipropylenowy biały**

index	wymiary		EAN
5580	60 cm × 105 cm	100	 5 906554 518693















**■ Rękaw foliowy „Słomka”**

index	rozmiar		EAN
6199	100 cm × 20 mb	6	 5 903076 913418

**■ Plandeka niebieska**



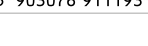



index	rozmiar	gramatura		EAN
5857	2 m × 3 m	60 g/m <sup>2</sup>	40	 5 906554 518655
5858	3 m × 4 m	60 g/m <sup>2</sup>	20	 5 906554 518662
5859	4 m × 5 m	60 g/m <sup>2</sup>	12	 5 906554 518679
5963	4 m × 6 m	60 g/m <sup>2</sup>	10	 5 903076 911063
5965	5 m × 6 m	60 g/m <sup>2</sup>	10	 5 903076 911087
5964	4 m × 8 m	60 g/m <sup>2</sup>	10	 5 903076 911070
5854	5 m × 8 m	60 g/m <sup>2</sup>	6	 5 906554 518792
5966	6 m × 8 m	60 g/m <sup>2</sup>	6	 5 903076 911094
5855	6 m × 10 m	60 g/m <sup>2</sup>	5	 5 906554 518808
5967	8 m × 10 m	60 g/m <sup>2</sup>	4	 5 903076 911100
5856	8 m × 12 m	60 g/m <sup>2</sup>	3	 5 906554 518815
5968	10 m × 12 m	60 g/m <sup>2</sup>	2	 5 903076 911117
5969	10 m × 15 m	60 g/m <sup>2</sup>	2	 5 903076 911124

■ Plandeka zielona

index	rozmiar	gramatura		EAN
5931	2 m × 3 m	90 g/m <sup>2</sup>	25	 5 903076 905055
5932	3 m × 4 m	90 g/m <sup>2</sup>	10	 5 903076 905062
5933	4 m × 5 m	90 g/m <sup>2</sup>	10	 5 903076 905079
5970	4 m × 6 m	90 g/m <sup>2</sup>	8	 5 903076 911131
5972	5 m × 6 m	90 g/m <sup>2</sup>	6	 5 903076 911155
5971	4 m × 8 m	90 g/m <sup>2</sup>	6	 5 903076 911148
5934	5 m × 8 m	90 g/m <sup>2</sup>	5	 5 903076 905086
5973	6 m × 8 m	90 g/m <sup>2</sup>	3	 5 903076 911162
5935	6 m × 10 m	90 g/m <sup>2</sup>	4	 5 903076 905093
5974	8 m × 10 m	90 g/m <sup>2</sup>	2	 5 903076 911179
5936	8 m × 12 m	90 g/m <sup>2</sup>	2	 5 903076 905109
5975	10 m × 12 m	90 g/m <sup>2</sup>	2	 5 903076 911186
5976	10 m × 15 m	90 g/m <sup>2</sup>	1	 5 903076 911193



■ Plandeka srebrna

index	rozmiar	gramatura		EAN
5937	2 m × 3 m	120 g/m <sup>2</sup>	20	 5 903076 905307
5938	3 m × 4 m	120 g/m <sup>2</sup>	10	 5 903076 905314
5939	4 m × 5 m	120 g/m <sup>2</sup>	5	 5 903076 905321
5941	5 m × 8 m	120 g/m <sup>2</sup>	3	 5 903076 905338
5942	6 m × 10 m	120 g/m <sup>2</sup>	2	 5 903076 905345
5943	8 m × 12 m	120 g/m <sup>2</sup>	1	 5 903076 905352



# NÓŻ DO GŁADZI PROFESSIONAL SERIES



DOBIERZ AKCESORIA:



Aluminium  
anodowane



Uchwyt  
systemowy  
index 6401  
str. 87

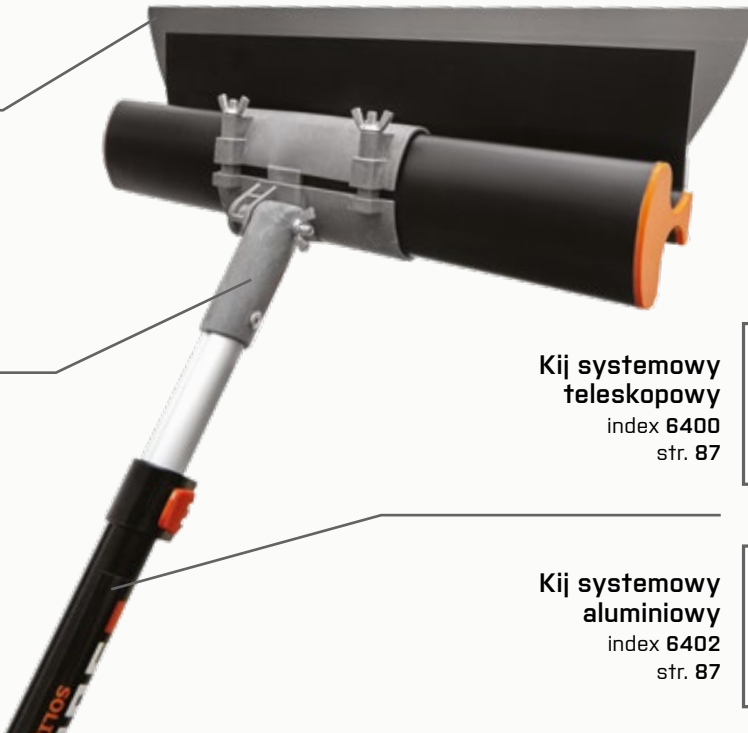

Kij systemowy  
teleskopowy  
index 6400  
str. 87



Kij systemowy  
alumiowy  
index 6402  
str. 87



PROFESSIONAL SERIES

■ **Nóż do gładzi Professional Series**

Stal nierdzewna, kwasoodporna, grubość: 0,3 mm;  
profil aluminiowy o podwyższonej sztywności

index	rozmiar		EAN
6409	250 mm	1	5 903076 900913
6410	350 mm	1	5 903076 900920
6411	450 mm	1	5 903076 900937
6412	550 mm	1	5 903076 900944
6413	650 mm	1	5 903076 900951
6414	800 mm	1	5 903076 900968
6415	1000 mm	1	5 903076 900975



### Uchwyt do noża do gładzi

index			EAN
6401		10	 5 903076 900180



### Kij systemowy teleskopowy

30% lżejszy niż standardowy kij, składany

index	rozmiar		EAN
6400	1,0 – 1,8 m	25	 5 903076 900142









### Kij systemowy aluminiowy

index	rozmiar		EAN
6402	1,6 m	10	 5 903076 900197



### Wałek do gładzi

index	rozmiar		EAN
6219	80 mm	5	 5 903076 906373
6220	180 mm	10	 5 903076 908131
6222	220 mm	5	 5 903076 906380
6221	250 mm	10	 5 903076 907349
6224	350 mm	5	 5 906554 518891
6226	460 mm	5	 5 906554 518914





■ Wałek do gładzi + rączka na CLICK



index	rozmiar		EAN
6201	80 mm	20	 5 903076 907615
6202	220 mm	20	 5 903076 907622

■ Wałek do gładzi do narożników



index	rozmiar		EAN
6209	36 mm	5	 5 903076 906397

■ Wałek do gładzi + rączka na CLICK



index	rozmiar		EAN
6203	36 mm	20	 5 903076 907424

**Zestaw do gładzi Professional Series**
**PROFESSIONAL SERIES**

index		EAN
6419	1	 5 903076 901057

Zestaw zawiera:		
6400	Kij systemowy teleskopowy	87
6401	Uchwyt do noża do gładzi	87
6410	Nóż do gładzi Professional Series 350 mm	86
6412	Nóż do gładzi Professional Series 550 mm	86
6414	Nóż do gładzi Professional Series 800 mm	86
6541	Wymienne ostrze do noża do gładzi Light 550 mm	90
6539	Uchwyt do noża do gładzi Light	91
6221	Walek do gładzi 250 mm	87
5304	Rączka MAXI Ø8 25 cm	48
6403	Walizka 120 cm	89



**Walizka 120 cm**

index		EAN
6403	1	 5 903076 900609



# NÓŻ DO GŁADZI SUPER LIGHT

DOBIERZ AKCESORIA:



**SUPER LEKKI!**

**40% lżejszy**  
niż standardowy  
nóż do gładzi



**Uchwyt do noża do gładzi Light**  
index 6539  
str. 91

**Kij systemowy teleskopowy**  
index 6400  
str. 87



**Kij systemowy aluminiowy**  
index 6402  
str. 87



**Wymienne ostrza do noża do gładzi Light**

Stal nierdzewna, kwasoodporna, grubość: 0,3 mm;  
profil aluminiowy o podwyższonej sztywności



index	rozmiar		EAN
6540	350 mm	10	5 903076 901002
6541	550 mm	10	5 903076 901019
6542	800 mm	10	5 903076 901026

■ **Nóż do gładzi Light - zestaw**



index		EAN
6538	3	 5 903076 900982

**Zestaw zawiera:** 

6400	Kij systemowy teleskopowy	87
6539	Uchwyt do noża do gładzi Light	91
6541	Wymienne ostrze do noża do gładzi Light 550 mm	90
6542	Wymienne ostrze do noża do gładzi Light 800 mm	90



■ **Uchwyt do noża do gładzi Light**

index		EAN
6539	10	 5 903076 900999

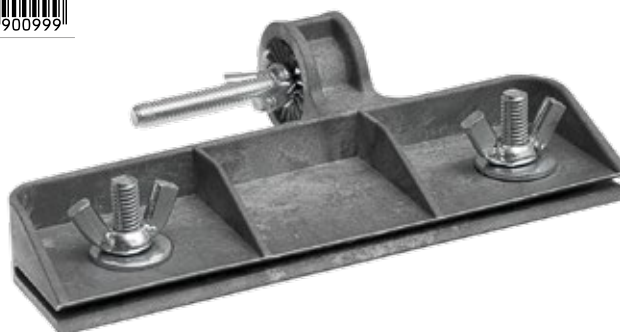

# SZPACHLA DO GŁADZI PROFESSIONAL SERIES



↓  
↑  
**0,3 mm**



Zaokrąglone,  
szlifowane rogi



Uchwyt do  
mocowania szpachli  
index 6355  
str. 94

Kij systemowy  
teleskopowy  
index 6400  
str. 87



Kij systemowy  
alumiowy  
index 6402  
str. 87



## ■ Szpachla do gładzi Professional Series

Stal nierdzewna, kwasoodporna, grubość: 0,3 mm;  
profil aluminiowy o podwyższonej sztywności



index	rozmiar	📦	EAN
6350	250 mm	5	5 903076 908742
6351	350 mm	5	5 903076 908759
6352	450 mm	5	5 903076 908766
6353	550 mm	5	5 903076 908773
6354	650 mm	5	5 903076 908780

### ■ Szpachla do gładzi r. 2K

Stal nierdzewna, kwasoodporna, grubość: 0,4 mm;  
profil aluminiowy o podwyższonej sztywności



0,4 mm



Zaokrąglony  
szlifowany  
narożnik

index	rozmiar		EAN
6099	150 mm	5	5 906554 516231
6100	250 mm	5	5 906554 516248
6101	350 mm	5	5 906554 516255
6098	450 mm	5	5 906554 511045
6102	550 mm	5	5 906554 516262
6103	650 mm	5	5 906554 516279



**DOBIERZ  
DO KOMPLETU**



**Kij systemowy  
teleskopowy**  
index **6400** str. **87**



**Kij systemowy  
aluminiowy**  
index **6402** str. **87**



**Uchwyt do  
mocowania szpachli**  
index **6355** str. **94**

### ■ Szpachla fasadowa r. 2K

Stal nierdzewna, kwasoodporna, grubość: 0,5 mm;  
profil aluminiowy o podwyższonej sztywności



0,5 mm



Zaokrąglony  
szlifowany  
narożnik

index	rozmiar		EAN
6077	150 mm	5	5 906554 514060
6082	250 mm	5	5 906554 514084
6090	350 mm	5	5 906554 514114
6091	450 mm	5	5 906554 514121
6092	550 mm	5	5 906554 514138
6096	650 mm	5	5 906554 510048



**DOBIERZ  
DO KOMPLETU**



**Kij systemowy  
teleskopowy**  
index **6400** str. **87**



**Kij systemowy  
aluminiowy**  
index **6402** str. **87**



**Uchwyt do  
mocowania szpachli**  
index **6355** str. **94**

### ■ Szpachla do gładzi Professional Series r. korek

index	rozmiar		EAN
21729	250 mm	5	5 903076 907721
21730	450 mm	3	5 903076 907738
21731	650 mm	3	5 903076 913432



**DOBIERZ  
DO KOMPLETU**



**Kij systemowy  
teleskopowy**  
index **6400** str. **87**



**Kij systemowy  
aluminiowy**  
index **6402** str. **87**



**Uchwyt do  
mocowania szpachli**  
index **6355** str. **94**



0,5 mm



**■ Szpachla fasadowa zębata r. 2K**

Stal nierdzewna, kwasoodporna, grubość: 0,5 mm;  
profil aluminiowy o podwyższonej sztywności

index	rozmiar	zęb		EAN
6277	450 mm	4 mm	5	5 903076 909701

**DOBIERZ  
DO KOMPLETU**



**Kij systemowy  
teleskopowy**  
index **6400** str. **87**



**Kij systemowy  
aluminiowy**  
index **6402** str. **87**



**Uchwyt do  
mocowania szpachli**  
index **6355** str. **94**



**■ Szpachla fasadowa nierdzewna**

Stal nierdzewna, grubość: 0,4 mm

index	rozmiar		EAN
5646	150 mm	10	5 906554 518365
5647	200 mm	10	5 906554 518372
5648	250 mm	10	5 906554 518389
5649	300 mm	10	5 906554 518396
5660	350 mm	10	5 906554 512332
5661	450 mm	10	5 906554 512349
5662	600 mm	10	5 906554 512356

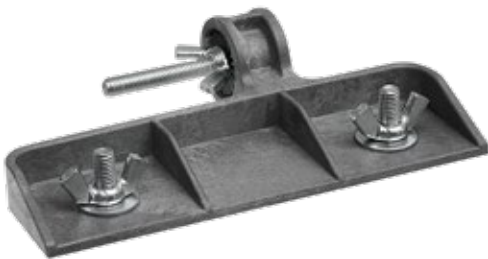

**■ Uchwyt do mocowania szpachli**

Uchwyt z pełną regulacją kąta

index		EAN
6355	5	5 903076 901064



**■ Uchwyt do mocowania szpachli fasadowej**

index		EAN
5990	10	5 906554 516811

### ■ Szpachelka r. drewno

Stal nierdzewna, kwasoodporna, szlifowana dla uzyskania odpowiedniej sprężystości

index	rozmiar		EAN
6336	50 mm	12	5 903076 913159
6337	100 mm	12	5 903076 913166
6338	150 mm	12	5 903076 913173
6339	200 mm	12	5 903076 913180



### ■ Szpachelka TPR

Stal nierdzewna, kwasoodporna, szlifowana dla uzyskania odpowiedniej sprężystości

index	rozmiar		EAN
6327	25 mm	12	5 903076 913074
6328	38 mm	12	5 903076 913081
6329	50 mm	12	5 903076 913098
6330	76 mm	12	5 903076 913104
6331	100mm	12	5 903076 913111
6332	125 mm	12	5 903076 913128
6333	150 mm	12	5 903076 913135
6334	200 mm	12	5 903076 913142



### ■ Szpachelka nierdzewna r. 2K

Stal nierdzewna, kwasoodporna, szlifowana dla uzyskania odpowiedniej sprężystości

index	rozmiar		EAN
6071	40 mm	12	5 906554 514008
6072	60 mm	12	5 906554 514015
6073	80 mm	12	5 906554 514022
6074	100 mm	12	5 906554 514039
6075	120 mm	12	5 906554 514046
6076	150 mm	12	5 906554 514053



### ■ Szpachelka nierdzewna r. 2K

Stal nierdzewna, kwasoodporna, szlifowana dla uzyskania odpowiedniej sprężystości

index	rozmiar		EAN
6261	40 mm	12	5 903076 909947
6262	60 mm	12	5 903076 909954
6263	80 mm	12	5 903076 909961
6264	100 mm	12	5 903076 909978
6265	120 mm	12	5 903076 909985
6266	150 mm	12	5 903076 909992





■ Szpachelka nierdzewna MULTI r. 2K  
 Stal nierdzewna, kwasoodporna

index		☐	EAN
6267		12	5 906554 519980



■ Szpachelka z bitem

index	rozmiar	☐	EAN
6278	150 mm	5	5 903076 903075



■ Szpachelka nierdzewna r. ABS  
 Stal nierdzewna, kwasoodporna

index	rozmiar	☐	EAN
5570	40 mm	6	5 906554 518228
5571	60 mm	6	5 906554 518235
5572	80 mm	6	5 906554 518242
5573	100 mm	6	5 906554 518259
5574	120 mm	6	5 906554 518266





■ Wybierak do wiadra

index	rozmiar	☐	EAN
6276	165 mm	5	5 903076 901972

### ■ Szpachelka nierdzewna

Stal nierdzewna, grubość: 0,5 mm

index	rozmiar		EAN
5324	40 mm	10	 5 906554 514770
5325	60 mm	10	 5 906554 514787
5326	80 mm	10	 5 906554 514794
5327	100 mm	10	 5 906554 514800



### ■ Szpachla nierdzewna

index	rozmiar		EAN
5323	37×120 mm	70	 5 906554 514763
5322	90×120 mm	60	 5 906554 514756



### ■ Szpachelki japońki

index	materiał		EAN
6085	stal nierdzewna	10	 5 902891 286639
6086	PVC	10	 5 902891 286646



### ■ Szpachla nierdzewna trapezowa zębata

Ząb kwadratowy

index	rozmiar	ząb		EAN
5654	150 mm	4 mm	12	 5 906554 518648
5653	150 mm	6 mm	12	 5 906554 518419
5579	150 mm	B11	12	 5 903076 903082



# PACA NIERDZEWNA Z GRYFEM ALUMINIOWYM



Ergonomiczny uchwyt dwukomponentowy

Zaokrąglone szlifowane narożniki

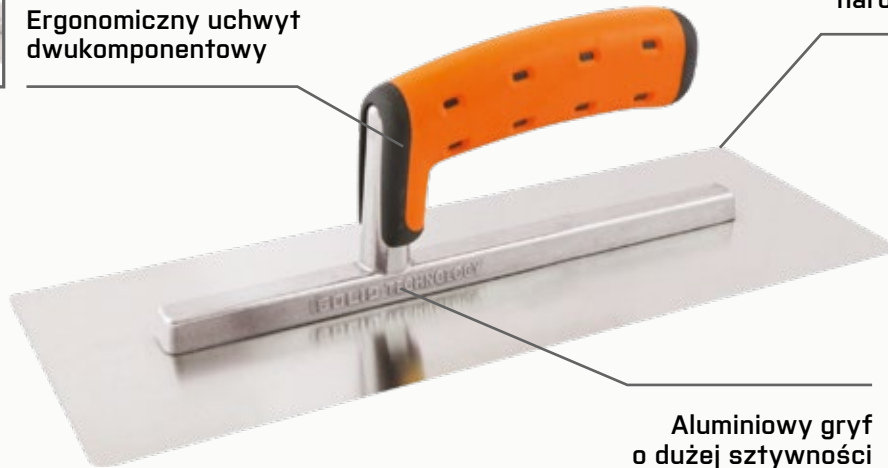
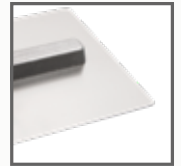

Aluminiowy gryf o dużej sztywności



## PROFESSIONAL SERIES



### ■ Paca nierdzewna Professional Series r. 2K

Gryf aluminiowy; stal nierdzewna, kwasoodporna, grubość: 0,7 mm

index	rozmiar	☐	EAN
6268	120×280 mm	6	5 903076 908605
6269	120×305 mm	4	5 903076 908612
6270	120×330 mm	4	5 903076 908629
6271	120×355 mm	4	5 903076 908636
6272	120×380 mm	4	5 903076 908643
6273	120×405 mm	4	5 903076 908650
6274	120×450 mm	4	5 903076 908667



### ■ Paca nierdzewna Premium r. korek

Gryf aluminiowy; stal nierdzewna, kwasoodporna, grubość: 0,7 mm

index	rozmiar	☐	EAN
21434	120×280 mm	6	5 903076 901583
21625	120×305 mm	4	5 903076 905444
21626	120×330 mm	4	5 903076 905451
21435	120×355 mm	4	5 903076 901590
21506	120×380 mm	4	5 903076 904010
21627	120×405 mm	4	5 903076 905468
21628	120×450 mm	4	5 903076 905475

**■ Paca nierdzewna r. 2K**

Gryf aluminiowy; stal nierdzewna, kwasoodporna, grubość: 0,7 mm

index	rozmiar		EAN
6000	120×270 mm	6	 5 906554 513674



**■ Paca nierdzewna zębata r. 2K**



Gryf aluminiowy; stal nierdzewna, kwasoodporna, grubość: 0,7 mm

index	rozmiar	ząb		EAN
6249	130×270 mm	2 mm	6	 5 906554 519997
6258	130×270 mm	3 mm	6	 5 903076 903709
6001	130×270 mm	4 mm	6	 5 906554 513681
6002	130×270 mm	6 mm	6	 5 906554 513698
6003	130×270 mm	8 mm	6	 5 906554 513704
6004	130×270 mm	10 mm	6	 5 906554 513711
6005	130×270 mm	12 mm	6	 5 906554 512998
6259	130×270 mm	15 mm	6	 5 903076 903716
6008	130×270 mm	B11 mm	6	 5 903076 901330



**■ Paca nierdzewna z zębem półokrągłym r. 2K**

Gryf aluminiowy; stal nierdzewna, kwasoodporna, grubość: 0,7 mm

index	rozmiar	ząb		EAN
6237	130×270 mm	półokrągły	6	 5 906554 519096



**■ Paca nierdzewna z zaokrąglonymi rogami r. 2K**

Gryf aluminiowy; stal nierdzewna, kwasoodporna, grubość: 0,7 mm

index	rozmiar		EAN
6020	130×270 mm	6	 5 906554 518785



**■ Paca nierdzewna wenecka r. korek**

Stal nierdzewna hartowana, grubość: 0,5 mm

index	rozmiar		EAN
21505	200 mm	10	 5 903076 904003
21504	240 mm	10	 5 903076 903990

**■ Paca wenecka r. 2K**

Stal nierdzewna hartowana, grubość: 0,65 mm

index	rozmiar		EAN
6034	80×200 mm	10	 5 906554 513858
6035	90/110×240 mm	10	 5 906554 513865

**■ Paca nierdzewna wygięta do płyt K-G r. 2K**

Gryf aluminiowy; stal nierdzewna, kwasoodporna, grubość: 0,7 mm

index	rozmiar		EAN
6275	120×300 mm	4	 5 903076 908674

**■ Paca nierdzewna do narzucania r. 2K**

Gryf aluminiowy; stal nierdzewna, kwasoodporna, grubość: 0,7 mm

index	rozmiar		EAN
6257	130×300 mm	6	 5 903076 900586

**■ Paca stalowa ostra r. 2K**

Gryf aluminiowy; Stal węglowa, grubość: 1,2 mm

index	rozmiar		EAN
6030	500 mm	2	5 906554 513810
6031	600 mm	2	5 906554 513827



**■ Paca nierdzewna r. drewno**

Gryf aluminiowy; stal nierdzewna, kwasoodporna, grubość: 0,7 mm

index	rozmiar		EAN
6006	130x270 mm	6	5 906554 513728



**■ Paca nierdzewna r. drewno FSC 100%**

Stal nierdzewna, kwasoodporna, grubość: 0,7 mm

index	rozmiar		EAN
6010	130x380 mm	4	5 906554 513742
6011	130x480 mm	4	5 906554 513759
6016	130x580 mm	4	5 906554 513797
6017	130x680 mm	4	5 906554 513803



**■ Paca nierdzewna zębata r. drewno FSC 100%**

Stal nierdzewna, kwasoodporna, grubość: 0,7 mm

index	rozmiar	ząb		EAN
6210	130x380 mm	6 mm	4	5 906554 518143
6211	130x380 mm	8 mm	4	5 906554 518150
6212	130x380 mm	10 mm	4	5 906554 518167
6213	130x380 mm	12 mm	4	5 906554 518174
6012	130x480 mm	6 mm	4	5 906554 513766
6013	130x480 mm	8 mm	4	5 906554 513773
6014	130x480 mm	10 mm	4	5 906554 513780
6019	130x480 mm	12 mm	4	5 906554 511052
6015	130x480 mm	półokrągły	4	5 906554 515555

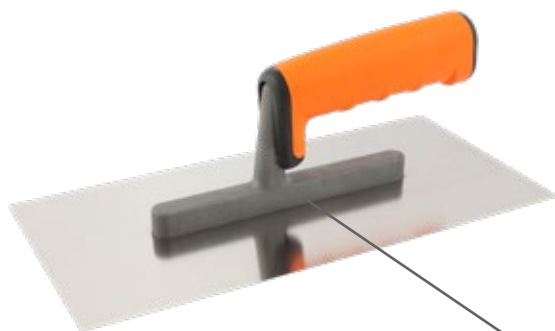

**■ Paca nierdzewna r. 2K**

Gryf kompozytowy; stal nierdzewna, kwasoodporna, grubość: 0,7 mm

index	rozmiar		EAN
6250	130×270 mm	6	5 906554 519416

 Lekki gryf  
 kompozytowy

**■ Paca nierdzewna r. 2K**

Gryf kompozytowy; stal nierdzewna, kwasoodporna, grubość: 0,7 mm

index	rozmiar		EAN
6048	120×280 mm	6	5 902891 286141
6049	120×305 mm	4	5 902891 286158
6050	120×330 mm	4	5 902891 286165
6051	120×355 mm	4	5 902891 286172
6052	120×380 mm	4	5 902891 286189
6053	120×405 mm	4	5 902891 286196



**■ Paca nierdzewna zębata r. 2K**

Gryf kompozytowy; stal nierdzewna, kwasoodporna, grubość: 0,7 mm

index	rozmiar	ząb		EAN
6247	130×270 mm	2 mm	6	5 903076 903747
6248	130×270 mm	3 mm	6	5 903076 903754
6251	130×270 mm	4 mm	6	5 906554 519423
6252	130×270 mm	6 mm	6	5 906554 519430
6253	130×270 mm	8 mm	6	5 906554 519447
6254	130×270 mm	10 mm	6	5 906554 519454
6255	130×270 mm	12 mm	6	5 906554 519461
6281	130×270 mm	15 mm	6	5 903076 903761
6283	130×270 mm	B11 mm	6	5 903076 903785

**■ Paca nierdzewna z zębem półokrągłym r. 2K**

Gryf kompozytowy; stal nierdzewna, kwasoodporna, grubość: 0,7 mm

index	rozmiar	ząb		EAN
6282	130×270 mm	półokrągły	6	5 903076 903778

### ■ Paca nierdzewna r. EURO

Stal nierdzewna, kwasoodporna, grubość: 0,7 mm

index	rozmiar		EAN
6009	130×270 mm	6	 5 906554 512103



### ■ Paca nierdzewna zębata r. EURO



Stal nierdzewna, kwasoodporna, grubość: 0,7 mm

index	rozmiar	ząb		EAN
6286	130×270 mm	2 mm	6	 5 903076 903723
6287	130×270 mm	3 mm	6	 5 903076 903730
6021	130×270 mm	4 mm	6	 5 906554 515715
6022	130×270 mm	6 mm	6	 5 906554 515722
6023	130×270 mm	8 mm	6	 5 906554 515739
6024	130×270 mm	10 mm	6	 5 906554 515746
6025	130×270 mm	12 mm	6	 5 906554 515753
6026	130×270 mm	15 mm	6	 5 906554 517658
6028	130×270 mm	B11 mm	6	 5 906554 512981



### ■ Paca nierdzewna z zębem półokrągłym r. EURO

Stal nierdzewna, kwasoodporna, grubość: 0,7 mm

index	rozmiar	ząb		EAN
6027	130×270 mm	półokrągły	6	 5 906554 512974



### ■ Paca nierdzewna r. ERGO

Stal nierdzewna, kwasoodporna, grubość: 0,7 mm

index	rozmiar		EAN
6018	130×270 mm	6	 5 906554 515531



**■ Paca nierdzewna zębata r. ERGO**

Stal nierdzewna, kwasoodporna, grubość: 0,7 mm

index	rozmiar	ząb		EAN
6214	130×270 mm	4 mm	6	 5 903076 909879
6215	130×270 mm	6 mm	6	 5 903076 909886
6216	130×270 mm	8 mm	6	 5 903076 909893
6217	130×270 mm	10 mm	6	 5 903076 909909
6218	130×270 mm	12 mm	6	 5 903076 909916

**■ Paca tarnik nierdzewny do wełny i styropianu**

Stal nierdzewna, kwasoodporna



index	rozmiar		EAN
6260	180×330 mm	2	 5 906554 511229

 Stal nierdzewna,  
 duża wytrzymałość

**■ Paca tarnik przelotowy**

index	rozmiar		EAN
6862	130×270 mm	20	 5 903076 907486
6859	160×380 mm	10	 5 903076 907479

**0,4 mm**

**■ Paca ABS r. EURO**

Tworzywo ABS, grubość płytki: 4 mm

index	rozmiar		EAN
6039	140×280 mm	20	 5 906554 514565

**■ Paca ABS r. ERGO**

Tworzywo ABS, grubość płytki: 4 mm



**0,4 mm**

index	rozmiar		EAN
6239	140×280 mm	6	5 906554 519812



**■ Paca z tworzywa PS r. PROFI**

Grubość płytki: 2 mm

index	rozmiar		EAN
5336	130×270 mm	6	5 906554 513520



**■ Paca styropianowa**

index	rozmiar	rodzaj		EAN
5370	130×270 mm	prosta	10	5 906554 511403
5371	170×320 mm	prosta	10	5 906554 511410
5354	140×400 mm	prosta	10	5 906554 512110
5372	130×600 mm	prosta	10	5 906554 511427
5373	140×700 mm	prosta	10	5 906554 511434
5374	140×1000 mm	prosta	10	5 906554 511441
5355	80×340 mm	skośna	10	5 906554 511182



**■ Paca styropianowa STRONG**

index	rozmiar		EAN
5993	140×280 mm	8	5 902891 286592
5994	180×320 mm	8	5 902891 286608
5995	140×500 mm	10	5 906554 516828

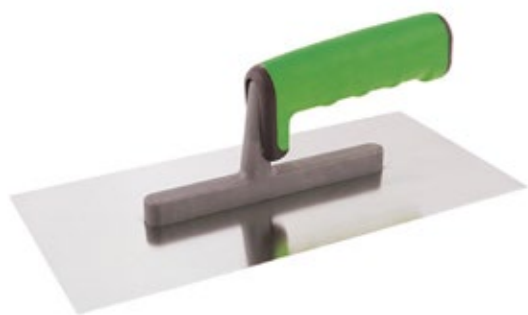

**Paca nierdzewna r. 2K**

Gryf kompozytowy; stal nierdzewna, grubość: 0,65 mm

index	rozmiar		EAN
5339	120×270 mm	6	 5 906554 514657

**Paca nierdzewna r. drewno**

Gryf kompozytowy; stal nierdzewna, grubość: 0,65 mm

index	rozmiar		EAN
5428	120×270 mm	6	 5 906554 517788

**Paca nierdzewna r. PROFI**

Stal nierdzewna, grubość: 0,65 mm

index	rozmiar		EAN
5321	120×270 mm	6	 5 906554 512059

**Paca nierdzewna r. drewno**

Stal nierdzewna, grubość: 0,65 mm

index	rozmiar		EAN
5347	120×380 mm	4	 5 906554 510147
5348	120×480 mm	4	 5 906554 510154
5349	120×580 mm	4	 5 906554 510161

**Paca nierdzewna zębata r. PROFI**

Stal nierdzewna, grubość: 0,65 mm

index	rozmiar	zęb		EAN
5341	120×270 mm	4 mm	6	 5 906554 513339
5342	120×270 mm	6 mm	6	 5 906554 513346
5343	120×270 mm	8 mm	6	 5 906554 513353
5344	120×270 mm	10 mm	6	 5 906554 513360
5345	120×270 mm	12 mm	6	 5 906554 513377

# PACA PRZEGUBOWA LIGHT

**30% LŹEJSZA**

NIŻ STANDARDOWA PACA PRZEGUBOWA

Wytrzymały uchwyt z tworzywa technicznego. Szybki montaż z lekkim aluminiowym kijem.



Kij systemowy teleskopowy  
index 6400

str. 87



Kij systemowy aluminiowy  
index 6402

str. 87

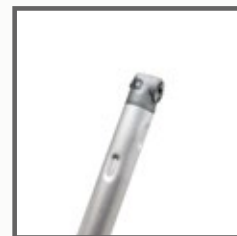

## ■ Paca przegubowa Light

index	rozmiar	grubość	☒	EAN
6405	200×400 mm	18 mm	2	5 903076 900548

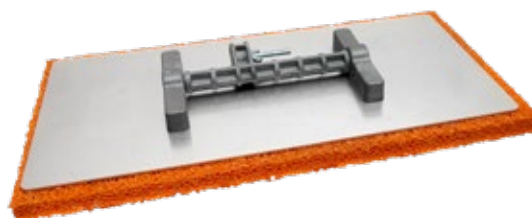

### DOBIERZ DO KOMPLETU



Kij systemowy teleskopowy  
str. 87

lub



Kij systemowy aluminiowy  
str. 87

# PACA PRZEGUBOWA STANDARD



Klasyczne  
stalowe mocowanie

Kij drewniany  
do pacy przegubowej  
index 5784  
str. 108



## ■ Paca styropianowa STRONG



index	rozmiar	grubość		EAN
6054	200x400 mm	18 mm	2	 5 906554 517511

## ■ Kij drewniany do pacy przegubowej

index	rozmiar		EAN
5784	180 cm	10	 5 906554 517368



### ■ Paca z gąbką gumową pomarańczową

index	rozmiar	grubość		EAN
6040	130×250 mm	18 mm	12	 5 906554 513896
6620	140×280 mm	18 mm	12	 5 903076 901071



### ■ Paca z gąbką gumową żółtą

index	rozmiar	grubość		EAN
5360	130×250 mm	18 mm	12	 5 906554 516866



### ■ Paca z gąbką gumową niebieską

index	rozmiar	grubość		EAN
6240	130×250 mm	18 mm	12	 5 906554 519378



### ■ Podkład do pac glazurniczych

index	rozmiar	grubość		EAN
6070	200×400 mm	18 mm	10	 5 906554 514978



**■ Dysk z gąbką gumową do zacierania**

index	rozmiar	gąbka		EAN
6373	∅ 400 mm	pomarańczowa 18 mm	10	5 903076 908711

**■ Gąbka do zacierania**

index	rozmiar	gąbka		EAN
6370	∅ 400 mm	szara 50 mm	5	5 903076 908681
6371	∅ 400 mm	hydrochlonna żółta 50 mm	5	5 903076 908698
6372	∅ 400 mm	hydrochlonna brązowa 50 mm	5	5 903076 908704

**■ Dysk z filcem do zacierania**

index	rozmiar	grubość		EAN
6204	∅ 360 mm	8 mm	10	5 906554 518754
6205	∅ 400 mm	8 mm	10	5 903076 908728

**■ Zdzierak do posadzek**

Ostrze ze stali hartowanej



index	rozmiar		EAN
6181	300 mm	4	5 906554 514541

**Trzonek drewniany do zdzieraka**

index	rozmiar		EAN
5786	150 mm	10	5 906554 519607

### ■ Zdzierak do tynków aluminiowy

index	rozmiar		EAN
6180	90×450 mm	5	 5 906554 514534



### ■ Zdzierak do tynków stalowy

index	rozmiar		EAN
6179	140×280 mm	6	 5 906554 510062



### ■ Zdzierak do tynków ECO

index	rozmiar		EAN
5398	130×250 mm	10	 5 903076 900043





### ■ Paca z filcem



index	rozmiar	grubość		EAN
6044	130×250 mm	8 mm	20	 5 906554 513933



**■ Paca z gąbką hydrochłonną żółtą**



index	rozmiar	grubość		EAN
6045	130×250 mm	30 mm	12	 5 906554 513940
6621	140×280 mm	30 mm	12	 5 903076 901088

**■ Paca z gąbką hydrochłonną żółtą nacinaną**

index	rozmiar	grubość		EAN
6106	130×250 mm	30 mm	12	 5 906554 518952
6622	140×280 mm	30 mm	12	 5 903076 901095

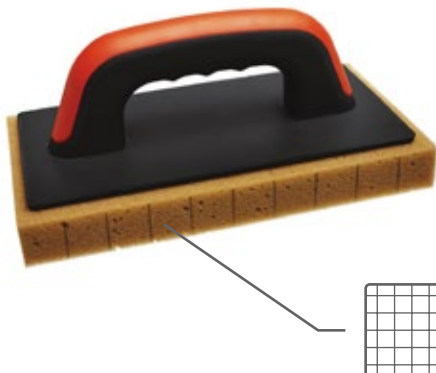

**■ Paca z gąbką hydrochłonną brązową**

index	rozmiar	grubość		EAN
6041	130×250 mm	30 mm	12	 5 906554 513902
6623	140×280 mm	30 mm	12	 5 903076 901101

**■ Paca z gąbką hydrochłonną brązową nacinaną**



index	rozmiar	grubość		EAN
6042	130×250 mm	30 mm	12	 5 906554 513919
6624	140×280 mm	30 mm	12	 5 903076 901118

### ■ Paca z gąbką szarą

index	rozmiar	grubość		EAN
6038	130×250 mm	30 mm	12	 5 906554 518983
6625	140×280 mm	30 mm	12	 5 903076 901125



### ■ Paca z gumą czarną

index	rozmiar	grubość		EAN
6043	130×250 mm	10 mm	20	 5 906554 513926
6626	140×280 mm	10 mm	16	 5 903076 901132



### ■ Paca z gumą białą

index	rozmiar	grubość		EAN
6109	130×250 mm	8 mm	20	 5 906554 518948





### ■ Paca z gąbką szorstką czerwoną





index	rozmiar	grubość		EAN
6108	130×250 mm	20 mm	12	 5 906554 518938



**■ Paca z włókniną**

index	rozmiar	włóknina		EAN
6058	120×250 mm	biała + czarna	9	 5 906554 513018

**Podkład z włókniny (2-pak)**

index	rozmiar	włóknina		EAN
6055	120×250 mm	biała + czarna	10	 5 906554 515852
6056	120×250 mm	czarna	10	 5 906554 515869
6233	120×250 mm	biała	10	 5 906554 519300

**■ Paca do spoinowania**

index	rozmiar		EAN
6847	95×255 mm	6	 5 903076 907493

**■ Paca szlifierska z gumą białą**

Podkład z pianki białej





index	rozmiar	grubość		EAN
6246	105×230 mm	4 mm	10	 5 906554 519348

**■ Paca tarnik z papierem ściernym**



index	rozmiar		EAN
6236	130×270 mm	20	 5 906554 514718
6238	160×380 mm	10	 5 906554 519867

■ Paca z filcem

index	rozmiar	grubość filcu		EAN
5338	130×270 mm	4 mm	20	 5 906554 516842
5331	130×270 mm	8 mm	20	 5 906554 514848





■ Paca z gąbką hydrochłoną żółtą

index	rozmiar	grubość		EAN
5362	130×270 mm	20 mm	12	 5 906554 510109



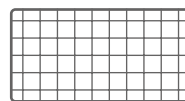

■ Paca z gąbką hydrochłoną żółtą nacinaną

index	rozmiar	grubość		EAN
5363	130×270 mm	20 mm	12	 5 906554 510093



■ Paca z gąbką hydrochłoną żółtą Profi

index	rozmiar	grubość		EAN
5686	130×270 mm	25 mm	12	 5 906554 519324



■ Paca z gąbką hydrochłonną żółtą Profi nacinaną

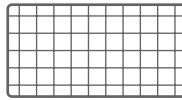

index	rozmiar	grubość		EAN
5686-2	130×270 mm	25 mm	12	 5 902891 286677

■ Paca z gąbką hydrochłonną brązową



index	rozmiar	grubość		EAN
5330	130×270 mm	30 mm	12	 5 906554 514831

■ Paca z gąbką hydrochłonną brązową nacinaną

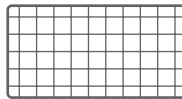

index	rozmiar	grubość		EAN
5337	130×270 mm	30 mm	12	 5 906554 514882

■ Paca z gąbką grafitową



index	rozmiar	grubość		EAN
5329	130×270 mm	20 mm	12	 5 906554 514824

### ■ Paca z gąbką szorstką czerwoną

index	rozmiar	grubość		EAN
5332	130×270 mm	20 mm	12	 5 906554 514855



### ■ Paca z gumą czarną

index	rozmiar	grubość		EAN
5424	130×270 mm	8 mm	20	 5 906554 517412



### ■ Paca szlifierska

Podkład z pianki czarnej

index	rozmiar	grubość		EAN
5367	100×220 mm	3 mm	30	 5 902891 286783



### ■ Fugownik

index	rozmiar		EAN
6187	150 mm	10	 5 906554 512066
6188	200 mm	10	 5 906554 512073
6189	250 mm	10	 5 906554 512080
6190	300 mm	10	 5 906554 512097



STAINLESS  
 STEEL

**■ Kielnia nierdzewna szturopłatkowa r. 2K**

Stal nierdzewna, kwasoodporna, grubość: 0,8 mm

index	rozmiar		EAN
6139	60 mm	55	5 906554 514381
6140	80 mm	55	5 906554 514398
6141	100 mm	50	5 906554 514404
6142	120 mm	45	5 906554 514411

 STAINLESS  
 STEEL

**■ Kielnia nierdzewna trapezowa r. 2K**

Stal nierdzewna, kwasoodporna, grubość: 1,0 mm

index	rozmiar		EAN
6206	55/80×140 mm	60	5 906554 518761
6122	90/110×140 mm	50	5 906554 514275
6123	85/115×160 mm	40	5 906554 514282
6124	90/120×180 mm	30	5 906554 514299

 STAINLESS  
 STEEL

**■ Kielnia nierdzewna kątowna wew. r. 2K**

Stal nierdzewna, kwasoodporna, grubość: 0,7 mm

index	rozmiar		EAN
6152	60×90 mm	25	5 906554 514473
6156	75×110 mm	25	5 906554 514510

 STAINLESS  
 STEEL

**■ Kielnia nierdzewna kątowna zew. r. 2K**

Stal nierdzewna, kwasoodporna, grubość: 0,7 mm

index	rozmiar		EAN
6153	60×90 mm	25	5 906554 514480
6157	75×110 mm	25	5 906554 514527

### ■ Kielnia nierdzewna do spoin r. 2K

Stal nierdzewna, kwasoodporna, grubość: 1,0 mm

index	rozmiar		EAN
6163	8 mm	30	 5 906554 514602
6164	10 mm	30	 5 906554 514619
6165	12 mm	30	 5 906554 514626



STAINLESS  
STEEL

### ■ Kielnia koci język wąska r. 2K

Stal nierdzewna, kwasoodporna, grubość: 1,0 mm

index	rozmiar		EAN
6166	160 mm	50	 5 906554 517719



STAINLESS  
STEEL

### ■ Kielnia koci język szeroka r. 2K

Stal nierdzewna, kwasoodporna, grubość: 1,0 mm

index	rozmiar		EAN
6208	160 mm	50	 5 906554 514633



STAINLESS  
STEEL

### ■ Kielnia nierdzewna kątowna obustronna r. 2K

Stal nierdzewna, kwasoodporna, grubość: 0,8 mm

index	rozmiar		EAN
6158	110 mm	25	 5 906554 518686



STAINLESS  
STEEL

STAINLESS  
 STEEL

**■ Kielnia nierdzewna szturopłatkarska r. drewno**

Stal nierdzewna, kwasoodporna, grubość: 0,8 mm

index	rozmiar		EAN
6133	60 mm	65	5 906554 514336
6134	80 mm	60	5 906554 514343
6135	100 mm	55	5 906554 514350
6136	120 mm	50	5 906554 514367

 STAINLESS  
 STEEL

**■ Kielnia nierdzewna trapezowa r. drewno**

Stal nierdzewna, kwasoodporna, grubość: 1,0 mm

index	rozmiar		EAN
6207	55/80×140 mm	60	5 906554 518778
6119	90/110×140 mm	60	5 906554 514244
6120	85/115×160 mm	50	5 906554 514251
6121	90/120×180 mm	40	5 906554 514268

 STAINLESS  
 STEEL

**■ Kielnia nierdzewna kątowna wew. r. drewno**

Stal nierdzewna, kwasoodporna, grubość: 0,7 mm

index	rozmiar		EAN
6150	60×90 mm	25	5 906554 514459
6154	75×110 mm	25	5 906554 514497

 STAINLESS  
 STEEL

**■ Kielnia nierdzewna kątowna zew. r. drewno**

Stal nierdzewna, kwasoodporna, grubość: 0,7 mm

index	rozmiar		EAN
6151	60×90 mm	25	5 906554 514466
6155	75×110 mm	25	5 906554 514503

### ■ Kielnia nierdzewna do spoin r. drewno

Stal nierdzewna, kwasoodporna, grubość: 1,0 mm

index	rozmiar		EAN
6160	8 mm	30	 5 906554 514572
6161	10 mm	30	 5 906554 514589
6162	12 mm	30	 5 906554 514596



STAINLESS  
STEEL

### ■ Kielnia nierdzewna do spoin r. drewno

Stal węglowa, grubość: 1,0 mm

index	rozmiar		EAN
5357	8 mm	12	 5 903076 912008
5358	10 mm	12	 5 903076 912015
5359	12 mm	12	 5 903076 912022



CARBON  
STEEL

### ■ Kielnia nierdzewna kątowa obustronna r. drewno

Stal nierdzewna, kwasoodporna, grubość: 0,8 mm

index	rozmiar		EAN
6167	110 mm	25	 5 906554 514640



STAINLESS  
STEEL

### ■ Kielnia stalowa sztukatorska r. drewno

Kielnia spawana, szlifowana obustronnie, stal węglowa, grubość: 1,2 mm

index	rozmiar		EAN
6131	80 mm	60	 5 906554 514312
6132	100 mm	55	 5 906554 514329



CARBON  
STEEL

CARBON  
 STEEL

**■ Kielnia stalowa trapezowa r. drewno**

 Kielnia spawana, szlifowana obustronnie, stal węglowa,  
 grubość: 1,2 mm

index	rozmiar		EAN
6116	65/80×140 mm	60	5 906554 514213
6117	65/80×160 mm	50	5 906554 514220
6118	85/110×180 mm	40	5 906554 514237

 CARBON  
 STEEL

**■ Kielnia trójkątna spawana r. 2K**

Kielnia spawana, stal węglowa

index	rozmiar		EAN
6643	180 mm	6	5 903076 901309
6644	200 mm	6	5 903076 901316
6645	220 mm	6	5 903076 901323

 CARBON  
 STEEL

**■ Kielnia trójkątna spawana r. drewno**

Kielnia spawana, stal węglowa

index	rozmiar		EAN
6640	180 mm	6	5 903076 901279
6641	200 mm	6	5 903076 901286
6642	220 mm	6	5 903076 901293

**■ Kielnia do betonu komórkowego**

index	rozmiar		EAN
6168	115 mm	10	5 902891 286042
6169	240 mm	10	5 902891 286059
6176	300 mm	8	5 902891 286127

**■ Zdzierak do betonu komórkowego**

index	rozmiar		EAN
6234	450 mm	10	 5 906554 515289



**■ Klucz do skręcania drutu**

index		EAN
6379	50	 5 903076 907899



**■ Kielnia nierdzewna sztukatorska r. drewno**

Stal nierdzewna, grubość: 0,65 mm

index	rozmiar		EAN
5380	60 mm	65	 5 906554 511151
5381	80 mm	60	 5 906554 511168
5382	100 mm	55	 5 906554 511175
5388	120 mm	50	 5 906554 517900



**■ Kielnia nierdzewna trapezowa r. drewno**

Stal nierdzewna, grubość: 0,8 mm

index	rozmiar		EAN
5383	55/80×140 mm	60	 5 906554 513292
5545	90/110×140 mm	60	 5 906554 517887
5384	85/115×160 mm	50	 5 906554 513308





- **Kielnia nierdzewna trapezowa r. drewno**  
 Kielnia spawana, szlifowana obustronnie, stal węglowa, grubość: 1,2 mm

index	rozmiar		EAN
5389	200 mm	10	5 906554 514671
5390	220 mm	10	5 906554 514688



- **Kielnia stalowa trójkątna r. drewno**  
 Kielnia spawana, stal węglowa, grubość: 1 mm

index	rozmiar		EAN
5401	180 mm	50	5 906554 517665



- **Kliny montażowo-nastawcze**

index	rozmiar	opakowanie		EAN
6530	średni 15×43×87 mm	paczka 20 szt.	100	5 903076 900746
6531	duży 24×43×135 mm	paczka 20 szt.	100	5 903076 903822
21568	średni 15×43×87 mm	karton 200 szt.	100	5 903076 904638
21624	duży 24×43×135 mm	karton 200 szt.	100	5 903076 905437



- **Zestaw kostek do wygładzania silikonu**

index		EAN
6378	200	5 903076 906403

■ Wiadro glazurnicze 20 l

index		EAN
5444	10	 5 902891 286578



■ Zestaw glazurniczy Mini

Zestaw zawiera: 

5444	Wiadro glazurnicze 20 l	125
5445	Rolki	126
5446	Kratka	126

index		EAN
5997	1	 5 906554 516835



■ Zestaw glazurniczy Standard

Zestaw zawiera: 

5444	Wiadro glazurnicze 20 l	125
5445	Rolki	126
5446	Kratka	126
6042	Paca glazurnicza	112
6847	Paca do spoinowania	114

index		EAN
5440	1	 5 906554 512400



■ Zestaw glazurniczy Professional

Zestaw zawiera: 

5444	Wiadro glazurnicze 20 l	125
5445	Rolki	126
5446	Kratka	126
6106	Paca glazurnicza	112
6847	Paca do spoinowania	114
6023	Paca nierdzewna ząb 8 mm	103
6140	Kielnia nierdzewna sztukatorska	118

index		EAN
5999	1	 5 902891 286615



■ Rolki do wiadra glazurniczego 20 l



index		EAN
5445	10	 5 902891 286585

■ Kratka do wiadra glazurniczego 20 l



index		EAN
5446	20	 5 906554 513995

■ Kółka do wiadra glazurniczego 20 l [4 szt.]



index		EAN
5447	10	 5 906554 510376

■ Gąbka hydrochłonna żółta



index	rozmiar		EAN
6228	140×110×70 mm	20	 5 906554 519218

■ Gąbka hydrochłonna Premium

index	rozmiar		EAN
6229	140×110×70 mm	20	 5 906554 518990

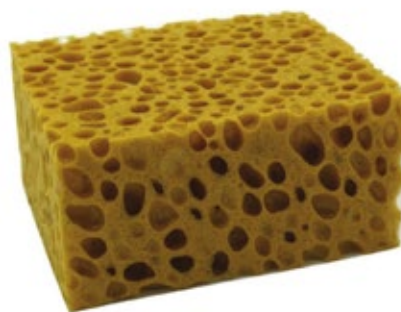



■ Gąbka hydrochłonna skośna

index	rozmiar		EAN
6079	160×90×60 mm	20	 5 906554 516071



■ Gąbka celulozowa

index	rozmiar		EAN
6227	150×110×60 mm	20	 5 906554 519669

 Dedykowana do pracy przy fugach epoksydowych



■ Gąbka hydrochłonna

index	rozmiar		EAN
5356	140×110×70 mm	20	 5 906554 510505



■ Zdzierak do spoin nasyp węglkowy



index	rozmiar		EAN
5703	50 mm	10	 5 906554 517313

■ Podeszwy z kolcami do wylewek



index		EAN
5448	10	 5 906554 510383

■ Repery do wylewek samoprzylepne



index	wysokość		EAN
6619	6 cm	10	 5 903076 912718

■ Wałek jeź do odpowietrzania wylewek

index	rozmiar	wys. kolca		EAN
5663	25 cm / Ø 73 mm	14 mm	5	 5 902891 286721



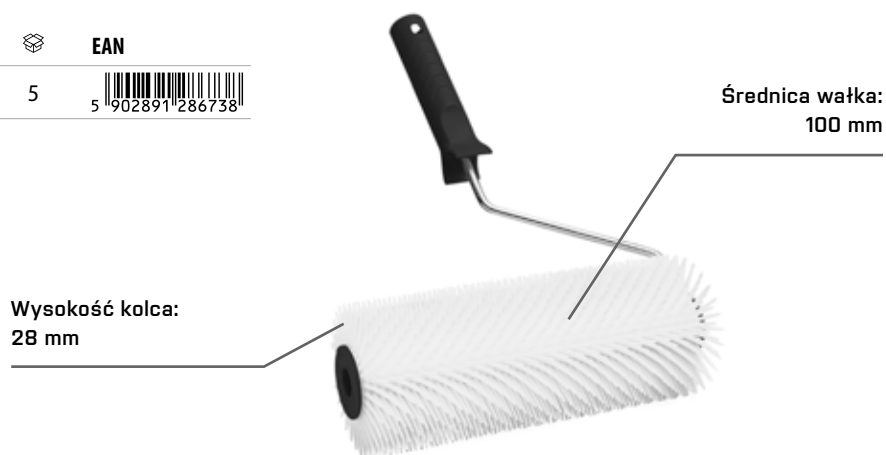

■ Wałek jeź do odpowietrzania wylewek

index	rozmiar	wys. kolca		EAN
5664	25 cm / Ø 100 mm	28 mm	5	 5 902891 286738



■ Wałek jeź do odpowietrzania wylewek

index	rozmiar	wys. kolca		EAN
5666	50 cm / Ø 100 mm	28 mm	1	 5 902891 286752



**Mieszadło do zapraw**

index	rozmiar		EAN
5403	80 mm	10	5 906554 510512
5404	100 mm	10	5 906554 510529
5405	120 mm	10	5 906554 511281

**Mieszadło do zapraw ze śrubą M14**

index	rozmiar		EAN
5412	120 mm	10	5 906554 511618
5415	140 mm	10	5 906554 512042
5416	160 mm	10	5 906554 510598

**Mieszadło do zapraw SDS**

index	rozmiar		EAN
5417	80 mm	10	5 903076 908940
5414	100 mm	10	5 906554 512028
5413	120 mm	10	5 906554 513537

**Mieszadło do zapraw Turbo Mix ze śrubą M14**

index	rozmiar		EAN
5418	120 mm	10	5 903076 900869
5400	140 mm	10	5 906554 511090

■ Mieszadło do tynków ze śrubą M14

index	rozmiar		EAN
5402	140 mm	10	 5 906554 518723



M14



■ Mieszadło do gipsów

index	rozmiar		EAN
5406	80 mm	10	 5 906554 510574
5407	100 mm	10	 5 906554 510581



HEX



■ Mieszadło do farb

index	rozmiar		EAN
5408	80 mm	10	 5 906554 510536
5409	100 mm	10	 5 906554 510543



HEX



■ Mieszadło do farb Profi

index	rozmiar		EAN
5524	60 mm	10	 5 906554 518426
5525	80 mm	10	 5 906554 518433
5419	100 mm	10	 5 903076 900876



HEX





■ Wiadro uniwersalne okrągłe

index	pojemność	EAN
5317	15 l	5 906554 515760
5426	33 l	5 906554 517450



■ Pokrywka do wiadra uniwersalnego

index	pojemność	EAN
5320	15 l	5 906554 519225
5427	33 l	5 906554 517474



■ Wiadro budowlane

index	pojemność	EAN
5430	5 l	5 902891 286790
5431	12 l	5 902891 286806
5432	16 l	5 902891 286813
5433	20 l	5 902891 286820



■ Pojemnik budowlany prostokątny

index	pojemność	EAN
5434	40 l	5 902891 286837
5435	60 l	5 902891 286844
5436	80 l	5 902891 286851

### ■ Pojemnik budowlany okrągły

index	pojemność	EAN
5437	45 l	5 902891 286868
5438	65 l	5 902891 286875
5439	90 l	5 902891 286882



### ■ Pojemnik do gipsu

index		EAN
6182	50	5 906554 512806



### ■ Gąbka ścierna

index	granulacja		EAN
5498	P46	10	5 903076 908827
5458	P60	10	5 906554 512592
5500	P80	10	5 906554 513575
5459	P100	10	5 906554 512608
5501	P120	10	5 906554 513582
5502	P150	10	5 906554 515326
5503	P180	10	5 906554 515333
5499	P220	10	5 906554 516989



### ■ Gąbka ścierna skośna

index	granulacja		EAN
5512	P46	10	5 903076 908834
5513	P60	10	5 903076 908841
5505	P80	10	5 906554 516729
5515	P100	10	5 906554 518860
5506	P120	10	5 906554 516736
5516	P150	10	5 906554 518877
5517	P180	10	5 903076 908865
5514	P220	10	5 903076 908858



**■ Siatka ścierna**

Rozmiar 105×265 mm



index	granulacja	opakowanie		EAN
5450	P46	paczka 5 szt.	50	5 906554 515876
5451	P60	paczka 5 szt.	50	5 906554 515883
5452	P80	paczka 5 szt.	50	5 906554 515890
5453	P100	paczka 5 szt.	50	5 906554 515906
5454	P120	paczka 5 szt.	50	5 906554 515913
5455	P150	paczka 5 szt.	50	5 906554 515920
5456	P180	paczka 5 szt.	50	5 906554 515937
5457	P220	paczka 5 szt.	50	5 906554 515944

**■ Krążek ścierny na rzep 3 szt.**

Średnica krążka: 225 mm

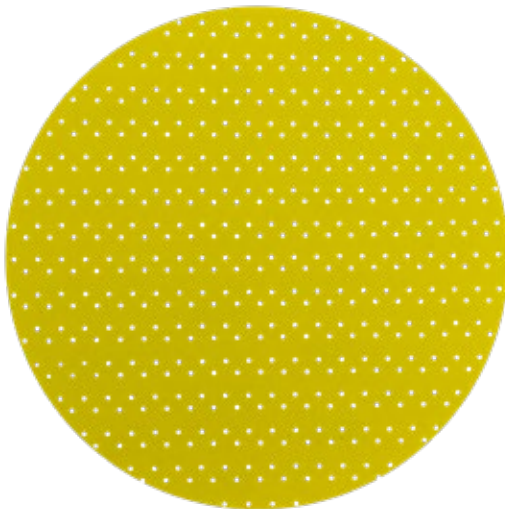

index	granulacja		EAN
6191	P40	50	5 906554 515388
6192	P60	50	5 906554 515395
6193	P80	50	5 906554 515401
6194	P100	50	5 906554 515517
6195	P120	50	5 906554 515524
6196	P150	50	5 906554 515449
6197	P180	50	5 906554 515456
6198	P220	50	5 906554 515463

### ■ Płótno ściernie w arkuszach

Rozmiar: 230×280 mm

index	granulacja		EAN
5507	P24	50	5 908211 722030
5508	P36	50	5 908211 722047
5469	P40	50	5 908211 722054
5470	P60	50	5 908211 722061
5471	P80	50	5 908211 722078
5472	P100	50	5 908211 722085
5473	P120	50	5 908211 722092
5474	P150	50	5 908211 722108
5475	P180	50	5 908211 722115
5476	P220	50	5 908211 722122
5477	P240	50	5 908211 722139



### ■ Papier ścierny w rolce YELLOW

Szerokość rolki: 115 mm

index	granulacja		EAN
5478	P40	50 mb	5 908211 722498
5479	P60	50 mb	5 908211 722504
5480	P80	50 mb	5 908211 722511
5481	P100	50 mb	5 908211 722528
5482	P120	50 mb	5 908211 722535
5483	P150	50 mb	5 908211 722542
5484	P180	50 mb	5 908211 722559
5494	P220	50 mb	5 908211 722566
5529	P40	5 mb	5 906554 515982
5530	P60	5 mb	5 906554 515999
5531	P80	5 mb	5 906554 516002
5532	P100	5 mb	5 906554 516019
5533	P120	5 mb	5 906554 516026
5534	P150	5 mb	5 906554 516033
5535	P180	5 mb	5 906554 516040



## ■ Krążek ścierny na rzep

Średnica: 125 mm



index	granulacja		EAN
5509	P24	50	5 903076 901989
5485	P36	50	5 906554 516606
5486	P40	50	5 906554 516613
5487	P60	50	5 906554 516620
5488	P80	50	5 906554 516637
5489	P100	50	5 906554 516644
5490	P120	50	5 906554 516651
5491	P150	50	5 906554 516668
5492	P180	50	5 906554 516675
5493	P220	50	5 906554 516682

## ■ Dysk do krążka na rzep

Średnica: 125 mm



index	rodzaj		EAN
5496	bez trzpienia	10	5 906554 517726
5497	z trzpieniem	10	5 906554 517733

## ■ Żyłka murarska



index	długość		EAN
5623	100 mb	100	5 906554 517573

### ■ Sznurek murarski

**NIE ROZCIĄGA SIĘ**

index	długość		EAN
6545	50 mb	100	 5 903076 905949
6546	100 mb	50	 5 903076 905956
6547	150 mb	64	 5 903076 913333



### ■ Sznurek murarski na rozwijaku

index	długość		EAN
6544	100 mb	96	 5 903076 910347



### ■ Sznurek murarski

index	długość		EAN
5680	50 mb	20	 5 906554 512417
5681	100 mb	20	 5 906554 512424



### ■ Sznurek polipropylenowy

index	długość		EAN
5575	200 mb	12	 5 906554 517924
5576	400 mb	6	 5 906554 517931
5577	1000 mb	2	 5 906554 517948
5578	2000 mb	1	 5 906554 517955



## ZAPROJEKTUJ WŁASNĄ EKSPOZYCJĘ LUB SKORZYSTAJ Z GOTOWEGO ROZWIĄZANIA

Naszym Klientom oferujemy profesjonalne systemy regałowe na oferowane przez nas wyroby. Cechuje je duża pojemność oraz wysoka estetyka wykonania. Nasz przedstawiciel pomoże Państwu dobrać optymalne rozwiązanie do Państwa potrzeb. Poniżej prezentujemy najpopularniejsze przykłady ekspozycji.

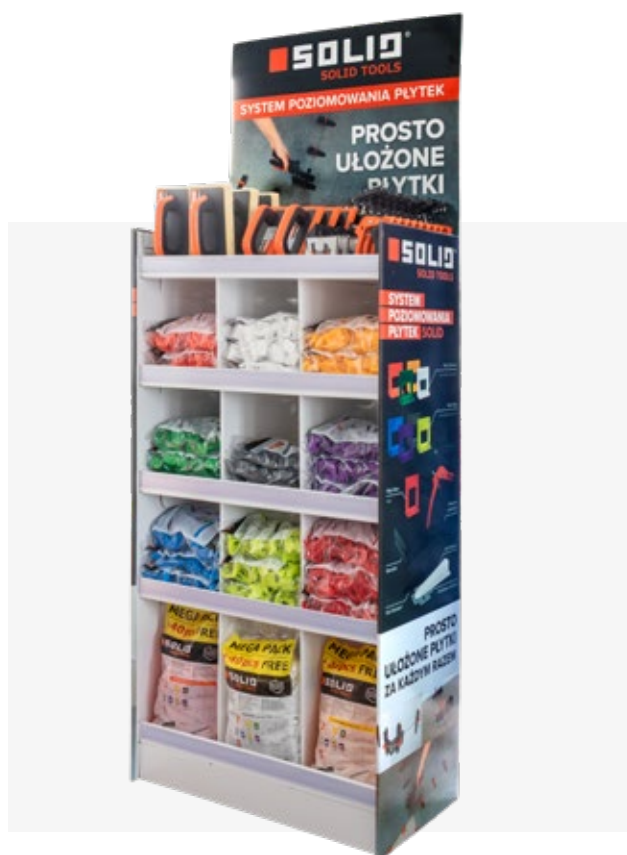

**1** Display do systemu poziomowania płytek

↓ 196 cm    ↓ 60 cm    ↓ 45 cm



**2** Display do noży do gładzi

↓ 156 cm    ↓ 69 cm    ↓ 47 cm

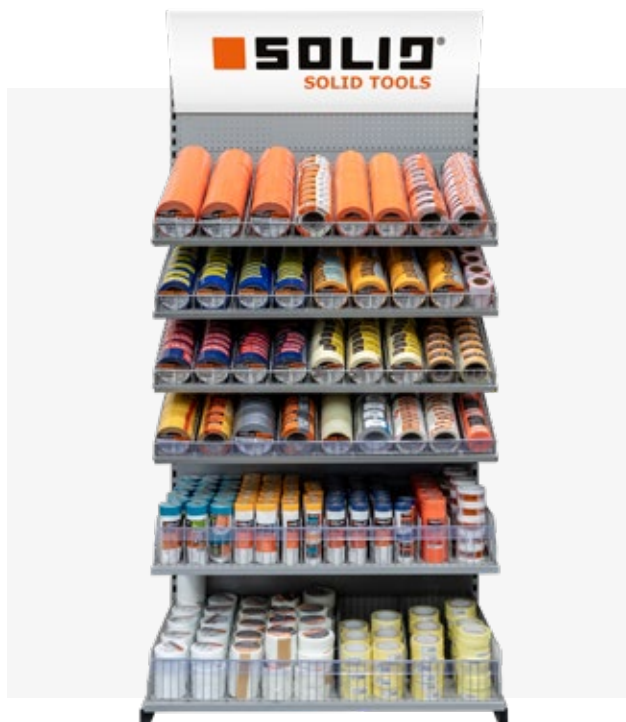

3

Regał taśmowy

↓ 230 cm   ↓ 120 cm   ↓ 70 cm



4

Regał malarski

↓ 230 cm   ↓ 240 cm (2x120 cm)   ↓ 70 cm



5

Regał narzędziowy

↓ 230 cm   ↓ 240 cm (2x120 cm)   ↓ 70 cm

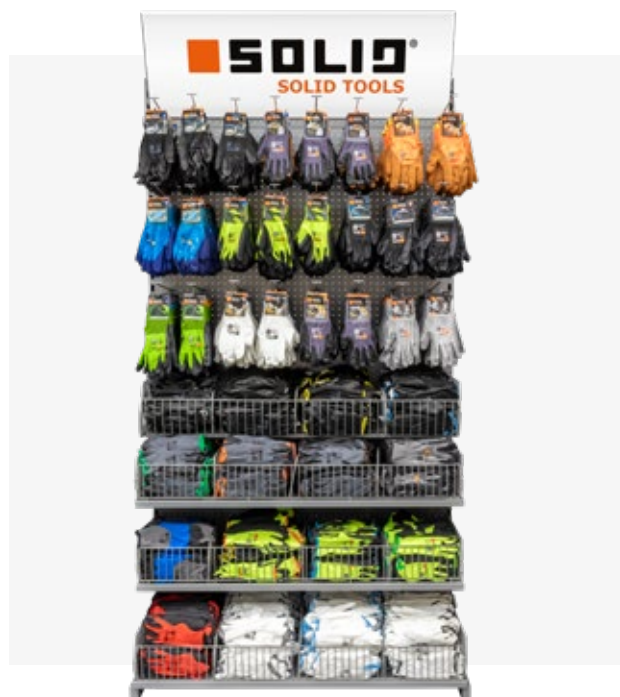

6

Regał na rękawice

↓ 230 cm   ↓ 120 cm   ↓ 70 cm



**7**

Regał obrotowy na rękawice

↓ 200 cm

↗ 85 cm

↘ 70 cm



Przykładowa ekspozycja, 7 regałów

↓ 230 cm   ↓ 840 cm   ↓ 70 cm



Przykładowa ekspozycja, 7 regałów

↓ 230 cm   ↓ 840 cm   ↓ 70 cm

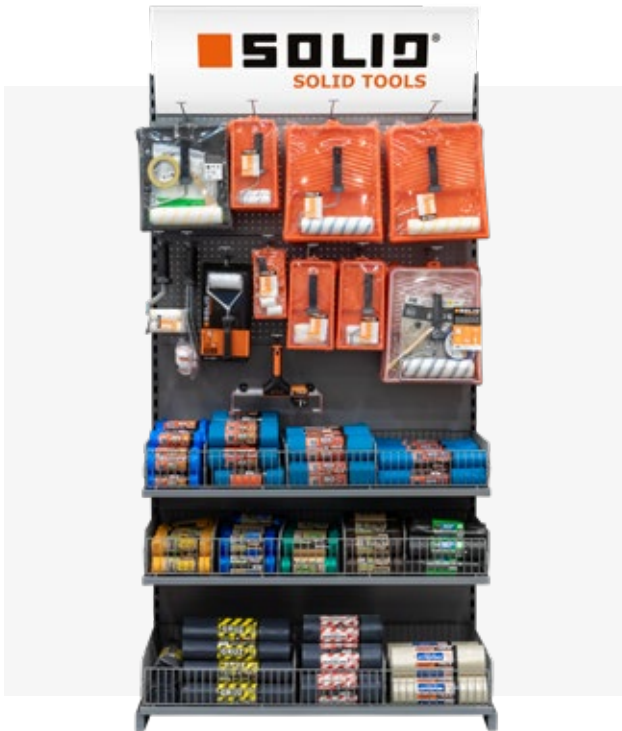

8

Regał malarsko-workowy

↓ 230 cm    ↓ 120 cm    ↓ 70 cm



9

Regał malarski

↓ 230 cm    ↓ 120 cm    ↓ 70 cm



10

Regał na worki

↓ 230 cm    ↓ 60 cm    ↓ 70 cm



11

Display na taśmy malarskie

↓ 195 cm    ↓ 42 cm    ↓ 40 cm



**12** Blister z miarką



**13** Kartonik z miarkami



**14** Blister z nożem



**15** Kartonik z nożami



## FHU PARTNER

---



+48 [58] 691 08 05  
+48 508 856 289

info@solidtools.pl  
f SolidToolsPl

www.solidtools.pl



1 Biuro handlowe i zakład produkcyjny  
ul. Pocztowa 32, 83-034 Trąbki Wielkie



2 Zakład produkcyjny  
ul. Dekarska 2, 83-031 Rusocin